

# Sumi Dual Mill DMSW Series

High-Productivity High-Feed Cutter for Rough Milling



**6-cornered Inserts**  
**Double-sided Inserts**

# Sumi Dual Mill DMSW Series



## General Features

- High productivity thanks to an ultra-high metal removal rate as well as high economic efficiency, due to the stable six-edged insert.
- The arc-shaped cutting edge reduces the cutting force to a minimum. High-efficiency machining at maximum feed rate per tooth of 3,5 mm/t is possible.

## Application Range

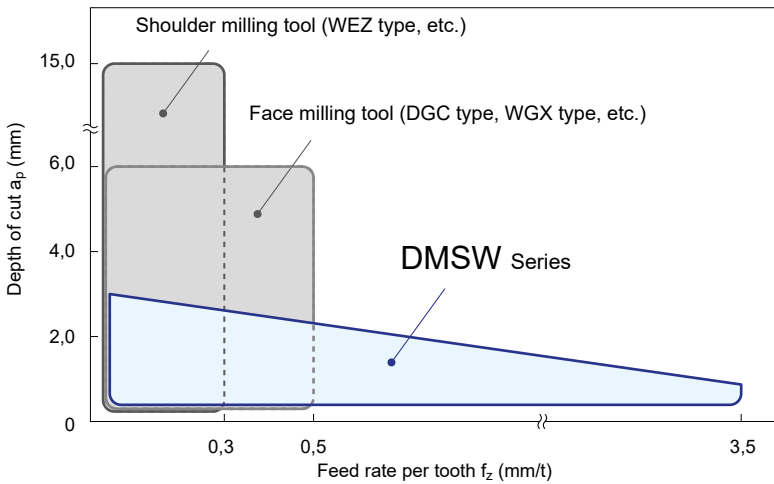

- Cutting depths up to 3 mm can be achieved. Feed rate per tooth up to 3,5 mm/t.
- Increases productivity.

## Product Range

Type	Cat. No.	Diameter range (mm) / No of teeth												Shape
		Ø35	Ø40	Ø42	Ø50	Ø52	Ø63	Ø66	Ø80	Ø85	Ø100	Ø125	Ø160	
Shell	DMSW 08000RS				4 5	4 5	4 5*	5 6	6 8	6 8	6	8	10	
	DMSW 08000R (Pouce)				4 5		4 5 6*		6 8		6	8	10	
Shank	DMSW 08000E	2	3		3		4							
	DMSW 08000EL	2	3		3		4							
Modular	DMSW 08000M	2	3	3										

\* Different shank diameters in stock

## Chipbreaker

Work Material	P Steel M Stainless steel K Cast iron	P Steel M Stainless steel K Cast iron
Applications	Main chipbreaker general-purpose to interrupted milling	Roughing, heavy interrupted cutting and hardened steel milling
	General purpose	High strength
Chip breaker	G type	H type
Cutting edge cross section	0,12 mm 	0,22 mm 

## Chipbreaker Selection Guide

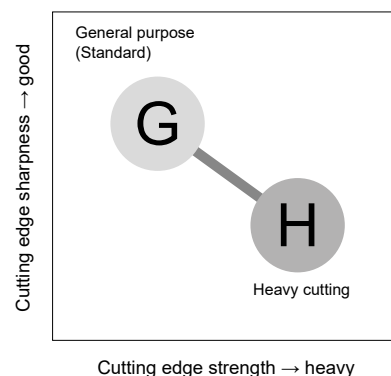

## Features

- A small chip cross-section due to a small cutting angle enables high feed rates per tooth.

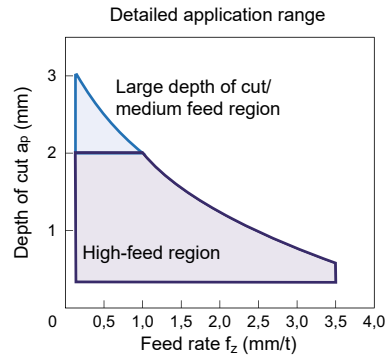
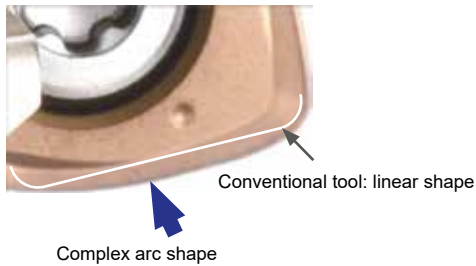

- Economical double-sided insert with 6-corner specification. Reassuring thick at 7 mm.

WNMU type



Conventional tool

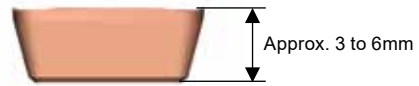

- Even at high feedrates of 2,0 mm/t or more, a reasonable surface finish can be attained.

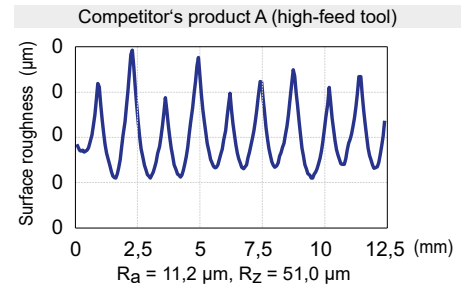
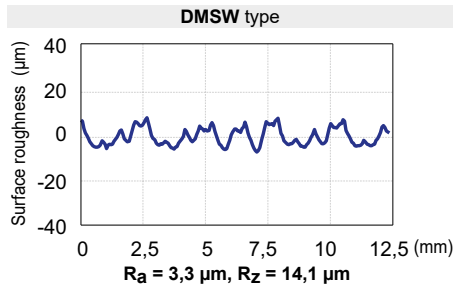
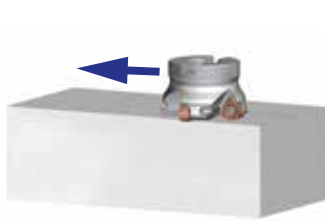

Machine:	Vertical machining centre BT50,	Work material:	C50	Insert:	WNMU 0807ZNER-G (ACU2500)
Tool:	DMSW 08063RS04	Cutting data:	$v_c = 150 \text{ m/min}$ , $f_z = 2,5 \text{ mm/t}$ , $a_p = 0,5 \text{ mm}$ , $a_e = 40 \text{ mm}$ , dry		

- Small cutting angle ( $15^\circ$ ) controls cutting force toward the back force direction. Suppresses chatter in long tool overhang machining, increasing efficiency.

DMSW type

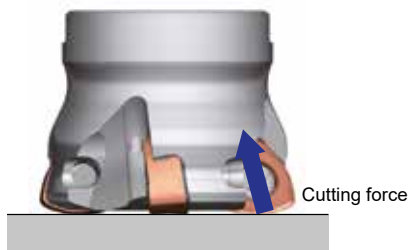

(Reference) Shoulder milling tool

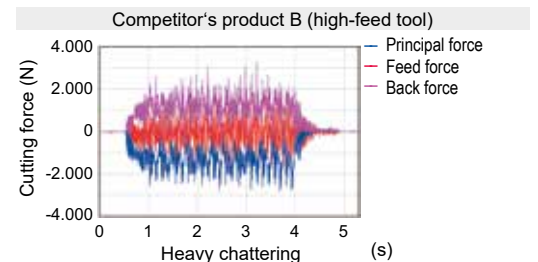
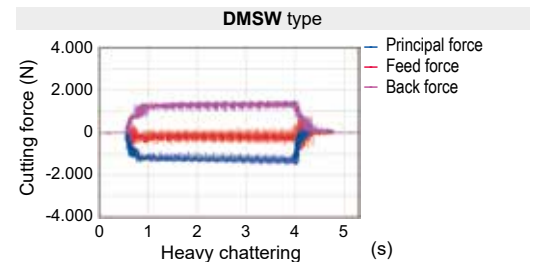
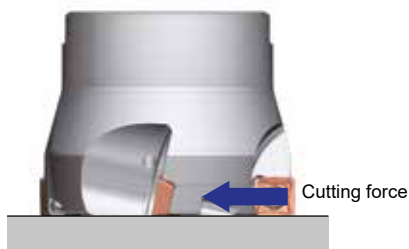

Machine:	Vertical machining centre BT50,	Work material:	C50
Tool:	DMSW 08050RS04	Insert:	WNMU 0807ZNER-G (ACU2500)
Cutting data:	$v_c = 160 \text{ m/min}$ , $f_z = 0,65 \text{ mm/t}$ , $a_p = 0,80 \text{ mm}$ , $a_e = 45 \text{ mm}$ , dry		

## Grade Application Range

In addition to **ACU2500** (capable of being used with various work materials), steel milling grades **ACP2000/ACP3000**, cast iron milling grades **ACK2000/ACK3000** and **ACS3000** for titanium alloys, heat-resistant alloys and stainless steel have now been added to the lineup.

ISO1		Finishing to light cutting	Medium cutting	Rough to heavy cutting
<b>P</b>	Coated carbide	ACU2500		
		ACP2000		ACP3000
<b>S</b>	Coated carbide		ACS3000	
<b>M</b>		ACU2500		
<b>K</b>	Coated carbide	ACU2500		
		ACK2000		ACK3000

The letters „C“ and „P“ at the end of each grade indicate the coating type.

▽ : CVD ▲ : PVD

## Grade Features

New coating technology that realises absolute stability  
**ABSOTECH™** (absolute technology)

**ABSOTECH** CVD

**Special Surface Treatment**  
Suppresses thermal cracking by introducing high compressive stress, resulting in chipping resistance more than twice as good as conventional types.

**Crystal Orientation Control Al<sub>2</sub>O<sub>3</sub>**  
By controlling the growth direction, Al<sub>2</sub>O<sub>3</sub> is reinforced for crater wear resistance more than twice as good as conventional types.

**High Hardness TiCN**  
Increased TiCN hardness by using a C-rich composition for flank wear resistance more than twice as good as conventional types.

Applicable grades: ACP2000, ACK2000

**ABSOTECH** PVD

**New Super Multi-Layered Structure**  
Higher hardness and twice the conventional wear resistance due to a fine crystal structure.  
AlTiCrBN-based nano-layered coating

**High Adhesion Strength**  
Coating adhesion significantly increased for twice or more the conventional chipping resistance.

Applicable grades: ACU2500, ACP3000, ACK3000

## Grade Characteristic Values

### CVD

Work material	Grade	Hardness (HRA)	TRS (GPa)	Coating type	Coating thickness (μm)	Features	Old grade
<b>P</b>	ACP2000	89,5	3,2	ABSOTECH	10	For high-speed machining of steel. Stable long tool life in high-speed machining is realised by adopting a tough carbide substrate and a new coating with excellent thermal crack resistance.	ACP100
<b>K</b>	ACK2000	91,7	3,1	ABSOTECH	10	For high-speed cast iron milling. Stable long tool life in high-speed machining is realised by adopting a tough carbide substrate and a new coating with excellent thermal resistance.	ACK100 ACK200

### PVD

Work material	Grade	Hardness (HRA)	TRS (GPa)	Coating type	Coating thickness (μm)	Features	Old grade
<b>P</b>	ACU2500	91,6	3,8	ABSOTECH	3	General purpose grade supporting steel, stainless steel and cast iron machining. Adopts a carbide substrate with excellent fracture resistance and wear resistance, plus a new coating with excellent wear resistance and chipping resistance, realising stable long tool life on various work materials.	—
	ACP3000	89,5	3,2	ABSOTECH	3	Our 1st recommended grade for milling steel. Carbide substrate with excellent thermal crack resistance plus a new coating with excellent wear resistance and chipping resistance, realises stable long tool life over a wide range of cutting conditions.	ACP200 ACP300
<b>S</b> <b>M</b>	ACS3000	89,8	3,4	ABSOTECH	3	High toughness carbide substrate and coating with excellent chipping resistance provide outstanding stability when machining titanium alloys, heat-resistant alloys or stainless steel	ACM300
<b>K</b>	ACK3000	91,7	3,1	ABSOTECH	3	Our 1st recommended grade for milling cast iron. Adopts a high thermal conductivity carbide substrate and a new coating with excellent wear resistance and chipping resistance, realising stable long tool life over a wide range of cast iron machining operations.	ACK300

## Precautions for Corner Finishing

Actual machined corners will have uncut and overcut portions due to the shape of the inserts.

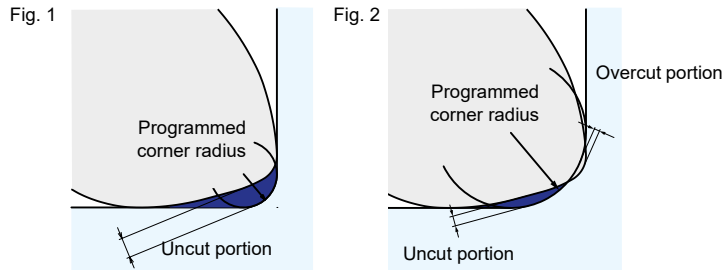

Programmed corner radius	Uncut portion	Overcut portion	Fig.
2,0	1,22	0	1
2,5	1,08	0	1
3,0	0,95	0	1
3,5	0,83	0,04	2

(mm)

## Ramping/Helical Milling Upper Limit

Ramping

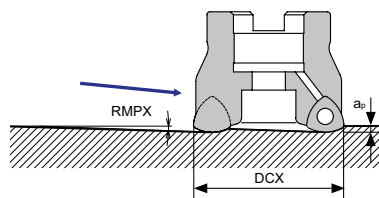

Helical Milling

≤ Min. diameter

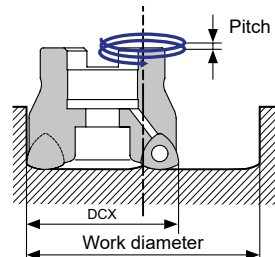

Below the min. machining diameter:  
Centre uncut portion cannot be removed by traverse cutting with the same cutter.

≥ Max. diameter

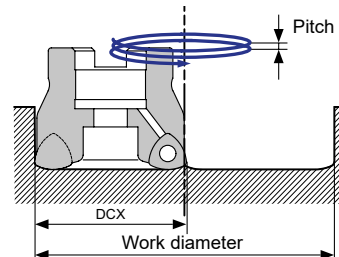

Above the max. machining diameter:  
Centre uncut portion can be removed by traverse cutting with the same cutter.

Max. dia. DCX (mm)	Ramping		Helical milling				
	Max. ramping angle RPMX (°)	Max. machining dia. (mm)	Max. pitch (mm/rev)	Standard diameter (mm)	Max. pitch (mm/rev)	Min. machining dia. (mm)	Max. pitch (mm/rev)
35	0,5	069,3	1,3	53,5	0,5	052,0	0,5
40	0,8	079,3	2,0	63,4	1,0	060,2	0,5
42	0,8	083,3	2,0	67,4	1,0	063,9	0,5
50	1,4	099,3	2,0	83,3	2,0	079,1	1,0
52	1,4	103,3	2,0	87,3	2,0	082,8	1,0
63	1,2	125,3	2,0	109,3	2,0	103,6	1,0
66	1,2	131,3	2,0	115,3	2,0	109,4	1,0
80	1,2	159,3	2,0	143,2	2,0	134,0	1,0
85	1,2	169,3	2,0	153,2	2,0	144,0	1,0
100	0,8	199,3	2,0	183,2	2,0	174,0	1,0
125	Not recommended						
160	Not recommended						

## Plunge Cutting Upper Limit

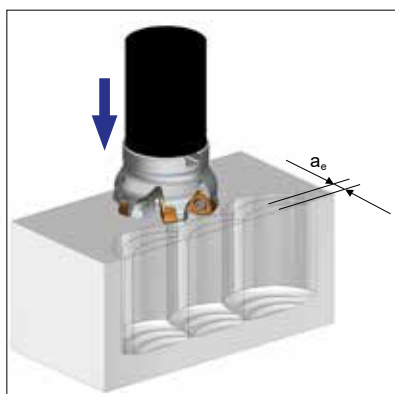

Max. $a_e$ (mm)	Max. $f_z$ (mm/t)
10	0,2

# Sumi Dual Mill

## DMSW 08000 R(S) Type

Rake angle	Radial	-7° to -10°	
	Axial	-6°	

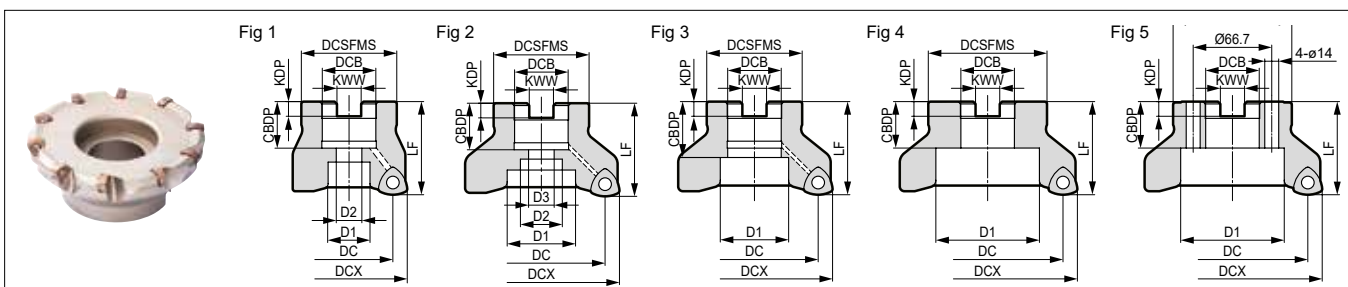

### Body (Shell Type)

Dimensions (mm)

Cat. No.	Stock	DCX	DC	DCSFMS	LF	DCB	KWW	KDP	CBBDP	D1	D2	D3	Number of teeth	Weight (kg)	Fig.	
Metric	DMSW 08050RS04	●	50	33,4	41	40	22	10,4	6,3	20	16,7	11	-	4	0,25	1
	08050RS05	●	50	33,4	41	40	22	10,4	6,3	20	16,7	11	-	5	0,24	1
	08052RS04		52	35,4	41	40	22	10,4	6,3	20	17	11	-	4	0,27	1
	08052RS05		52	35,4	41	40	22	10,4	6,3	20	17	11	-	5	0,25	1
	08063RS04	●	63	46,4	50	40	22	10,4	6,3	20	18	11	-	4	0,46	1
	08063RS05	●	63	46,4	50	40	22	10,4	6,3	20	18	11	-	5	0,46	1
	08063RS06	●	63	46,4	50	40	22	10,4	6,3	20	18	11	-	6	0,44	1
	08063RS05-27	●	63	46,4	50	50	27	12,4	7	22	20	14	-	5	0,55	1
	08063RS06-27	●	63	46,4	50	50	27	12,4	7	22	20	14	-	6	0,53	1
	08066RS05-27		66	49,4	50	50	27	12,4	7	22	20	14	-	5	0,60	1
	08066RS06-27		66	49,4	50	50	27	12,4	7	22	20	14	-	6	0,58	1
	08080RS06	●	*80	63,3	55	50	27	12,4	7	22	20	14	-	6	0,88	1
	08080RS08	●	*80	63,3	55	50	27	12,4	7	22	20	14	-	8	0,84	1
	08100RS06	●	100	83,3	70	50	32	14,4	8	32	46	-	-	6	1,29	3
	08125RS08	●	125	108,3	80	63	40	16,4	9	29	52	29	-	8	2,41	1
08160RS10	●	160	143,3	130	63	40	16,4	9	29	90	-	-	10	4,73	5	
Inch	DMSW 08050R04	○	50	33,4	41	40	22,225	8,4	5	20	16,7	11	-	4	0,25	1
	08050R05	○	50	33,4	41	40	22,225	8,4	5	20	16,7	11	-	5	0,24	1
	08063R04	○	63	46,4	50	40	22,225	8,4	5	20	18	11	-	4	0,46	1
	08063R05	○	63	46,4	50	40	22,225	8,4	5	20	18	11	-	5	0,46	1
	08063R06	○	63	46,4	50	40	22,225	8,4	5	20	18	11	-	6	0,44	1
	08080R06	○	*80	63,3	70	63	31,75	12,7	8	32	27	18	-	6	1,32	1
	08080R08	○	*80	63,3	70	63	31,75	12,7	8	32	27	18	-	8	1,28	1
	08100R06	○	*100	83,3	70	63	31,75	12,7	8	32	46	27	18	6	1,75	2
	08125R08	○	125	108,3	80	63	38,1	15,9	10	35,5	55	30	-	8	2,55	1
	08160R10	○	160	143,3	100	63	50,8	19,1	11	38	72	-	-	10	4,18	4

Take note of the cutter mounting size (DCB) when selecting a cutter. Inserts are sold separately.

For mounting the Ø 80 mm, Ø 85 mm and Ø 100 mm sized cutters marked with \* to an arbor, use a JIS B1176 hexagonal socket bolt (metric specification : M12x30 to 35 mm, inch specification: M16x40 to 45 mm).

### Parts

Applicable cutters	Insert screw		Wrench	Handle grip	Wrench bit
DMSW 08160R(S)10 Other than above	BFTX0513IP	5,0	TRDR20IP	-	-
			-	HPL2025	TPB20IP

### Identification Details

<b>DMSW 08</b>	<b>063</b>	<b>R</b>	<b>S</b>	<b>05</b>	<b>- 27</b>
Cutter series	Insert size	Cutter diameter	Feed direction	Metric	Number of teeth Mounting size

### Recommended Cutting Conditions

→ P.7

### Inserts

Dimensions (mm)

Application	Coated carbide						IC	S	RE	Fig.
High speed / Light cut		P		K						
General purpose		P	P	K	K	M				
Roughing			P		K	M				
Cat. No.	ACU2500	ACP2000	ACP3000	ACK2000	ACK3000	ACS3000				
WNMU 0807ZNER-G	●	●	●	●	●	●	13	7	1,6	1
WNMU 0807ZNER-H	●	●	●	●	●	●	13	7	1,6	1

Fig 1

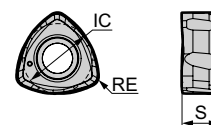

● = Euro stock

○ = Japan stock

# Sumi Dual Mill DMSW 08000 E(L) Type

Rake angle	Radial	-7° to -10°	3 mm	15°
	Axial	-6°		

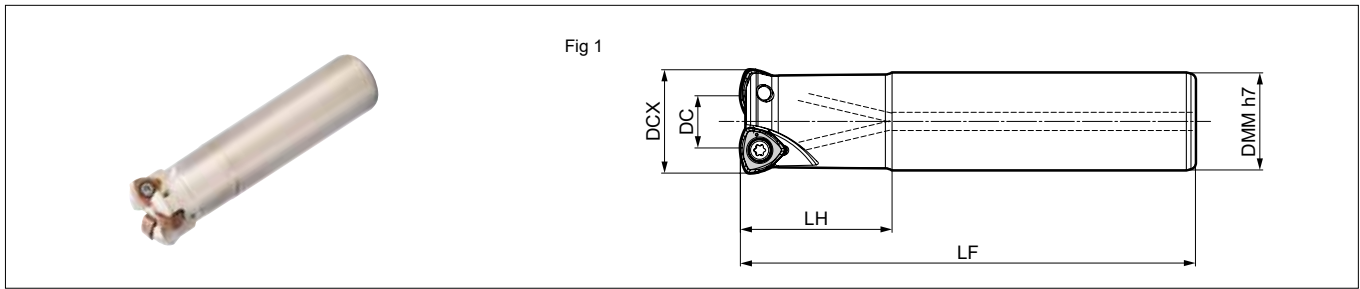

## Body (Shank Type)

Dimensions (mm)

Cat. No.	Stock	DCX	DC	DMM	LH	LF	Number of teeth	Weight (kg)	Fig.
DMSW 08035E02	●	35	18,6	32	50	150	2	0,85	1
08040E03	●	40	23,5	32	50	150	3	0,86	1
08050E03-42	●	50	33,4	42	50	150	3	1,51	1

Inserts are sold separately.

## Body (Long Shank Type)

Dimensions (mm)

Cat. No.	Stock	DCX	DC	DMM	LH	LF	Number of teeth	Weight (kg)	Fig.
DMSW 08035EL02	●	35	18,6	32	60	210	2	1,21	1
08040EL03	●	40	23,5	32	60	210	3	1,22	1
08050EL03-42	●	50	33,4	42	50	250	3	2,54	1

Inserts are sold separately.

## Parts

Insert screw	Wrench
BFTX0513IP	TRDR20IP

## Identification Details

<b>DMSW</b>	<b>08</b>	<b>050</b>	<b>E</b>	<b>L</b>	<b>03</b>	<b>-</b>	<b>42</b>
Cutter series	Insert size	Cutter diameter	Shank	Long shank type	Number of teeth		Shank diameter

## Inserts

Dimensions (mm)

Application	Coated carbide										
High speed / light cut		P		K							
General purpose		P	P	K	K	M S					
Roughing			P		K	M S					
Cat. No.	ACU2500	ACP2000	ACP3000	ACK2000	ACK3000	ACS3000	IC	S	RE	Fig.	
WNMU 0807ZNER-G	●	●	●	●	●	●	13	7	1,6	1	
WNMU 0807ZNER-H	●	●	●	●	●	●	13	7	1,6	1	

Fig 1

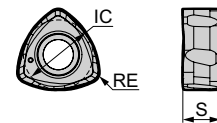

## Recommended Cutting Conditions

min.–optimum–max.

ISO	Work material	Hardness	Cutting speed $V_c$ (m/min)	Feed rate $f_z$ (mm/t)	Grade
P	General steel	< 280 HB	100– <b>160</b> –250	1,0– <b>1,5</b> –2,0	ACU2500/ACP2000/ ACP3000
	Alloy steel	< 280 HB	100– <b>160</b> –200	1,0– <b>1,5</b> –1,8	ACU2500/ACP2000/ ACP3000
	Alloy steel	< 42 HRC	100– <b>150</b> –180	0,8– <b>1,0</b> –1,2	ACU2500/ACP2000/ ACP3000
M	Stainless steel	–	80– <b>120</b> –150	0,8– <b>1,0</b> –1,2	ACU2500/ ACS3000
K	Cast iron	–	100– <b>160</b> –250	1,0– <b>1,5</b> –1,8	ACU2500/ACK2000/ACK3000
S	Heat Resistant Alloy	–	20– <b>30</b> –40	0,3– <b>0,5</b> –0,7	ACU2500/ ACS3000
	Titanium Alloy	–	30– <b>50</b> –70	0,4– <b>0,6</b> –0,8	ACU2500/ ACS3000
H	Hardened steel	< 52 HRC	80– <b>100</b> –120	0,3– <b>0,5</b> –0,7	ACU2500/ ACP3000

The above figures are guidelines for use with BT50 machine tools at depth of cut ( $a_p$ ) of 1,5 mm.

The above recommended cutting conditions may require adjustment depending on machine rigidity and workpiece rigidity.

● = Euro stock

# Sumi Dual Mill DMSW 08000 M Type

## Modular Type

Rake angle	Radial	-11° to -13°	
	Axial	-6°	

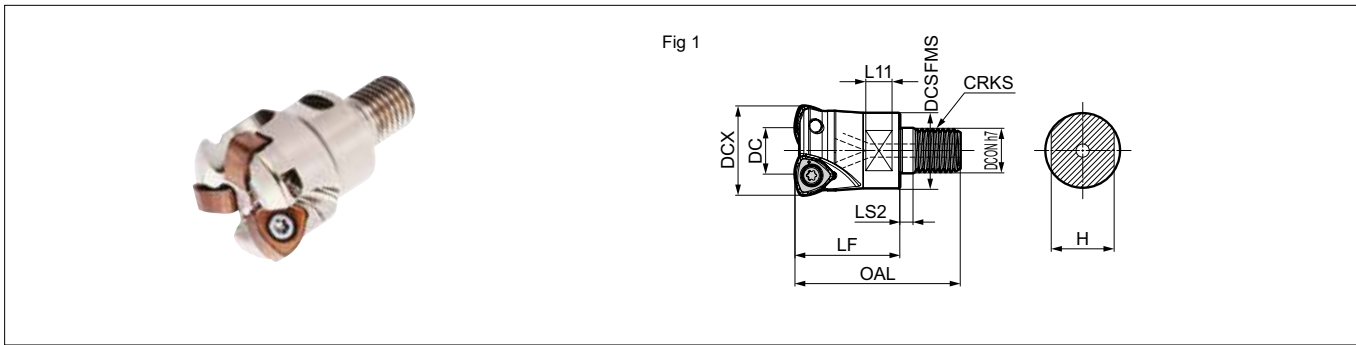

### Head

Dimensions (mm)

Cat. No.	Stock	DCX	DC	DCSFMS	DCON	CRKS	OAL	LF	LS2	L11	H	Number of teeth	Weight (kg)	Fig.
DMSW 08035M16Z2	●	35	18,6	28,5	17	M16	63	40	5	10	24	2	0,19	1
08040M16Z3	●	40	23,5	28,5	17	M16	63	40	5	10	24	3	0,21	1

Inserts are sold separately.

### Parts

Insert screw	Wrench
BFTX0513IP	TRDR20IP

### Identification Details

**DMSW 08 040 M16 Z3**

Cutter series    Insert size    Cutter diameter    Mounting screw size    Number of teeth

### Inserts

Dimensions (mm)

Application	Coated carbide									
							IC	S	RE	Fig.
High speed / light cut										
General purpose										
Roughing										
Cat. No.	ACU2500	ACP2000	ACP3000	ACK2000	ACK3000	ACS3000	IC	S	RE	Fig.
WNMU 0807ZNER-G	●	●	●	●	●	●	13	7	1,6	1
WNMU 0807ZNER-H	●	●	●	●	●	●	13	7	1,6	1

Fig 1

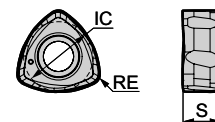

### Recommended Cutting Conditions

min.–optimum–max.

ISO	Work material	Hardness	Cutting speed $v_c$ (m/min)	Feed rate $f_z$ (mm/t)	Grade
<b>P</b>	General steel	< 280 HB	100– <b>160</b> –250	1,0– <b>1,5</b> –2,0	ACU2500/ACP2000/ ACP3000
	Alloy steel	< 280 HB	100– <b>160</b> –200	1,0– <b>1,5</b> –1,8	ACU2500/ACP2000/ ACP3000
	Alloy steel	< 42 HRC	100– <b>150</b> –180	0,8– <b>1,0</b> –1,2	ACU2500/ACP2000/ ACP3000
<b>M</b>	Stainless steel	–	80– <b>120</b> –150	0,8– <b>1,0</b> –1,2	ACU2500/ ACS3000
<b>K</b>	Cast iron	–	100– <b>160</b> –250	1,0– <b>1,5</b> –1,8	ACU2500/ACK2000/ACK3000
<b>S</b>	Heat Resistant Alloy	–	20– <b>30</b> –40	0,3– <b>0,5</b> –0,7	ACU2500/ ACS3000
	Titanium Alloy	–	30– <b>50</b> –70	0,4– <b>0,6</b> –0,8	ACU2500/ ACS3000
<b>H</b>	Hardened steel	< 52 HRC	80– <b>100</b> –120	0,3– <b>0,5</b> –0,7	ACU2500/ ACP3000

The above figures are guidelines for use with BT50 machine tools at depth of cut ( $a_e$ ) of 1,5 mm.  
The above recommended cutting conditions may require adjustment depending on machine rigidity and workpiece rigidity.



## ■ BBT Integrated Type - Modular Tools Special Arborg

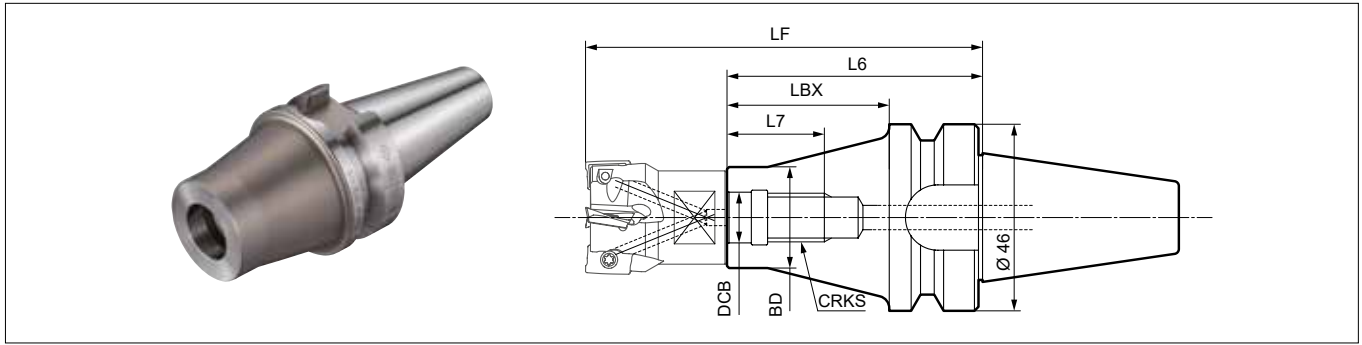

## ■ BBT Integrated Arbor

Dimensions (mm)

Cat. No.	Stock	CRKS	DCB	BD	L6	LBX	L7	LF*	Coolant hole
BBT30-M16-35	○	M16	17	31,9	58	35	24	98	yes

\* Overhang length for LF is with head mounted. Can also be used with BT30 special machines.

## ■ Carbide and Steel Arbor

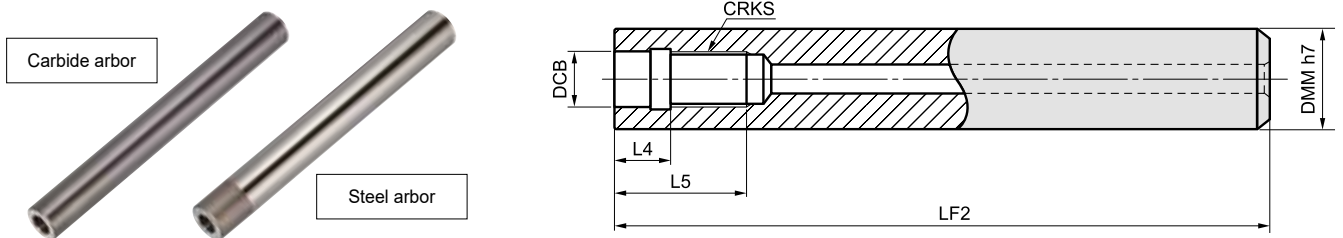

## ■ Carbide Arbor

Dimensions (mm)

Cat. No.	Stock	CRKS	DCB	DMM	LF2	L4	L5	LF*
MA 28 M16 L200C	●	M16	17,0	28	200	10	24	240
28 M16 L300C	●	M16	17,0	28	300	10	24	340
MA 32 M16 L200C	●	M16	17,0	32	200	10	24	240
32 M16 L300C	●	M16	17,0	32	300	10	24	340

## ■ Steel Arbor

Dimensions (mm)

Cat. No.	Stock	CRKS	DCB	DMM	LF2	L4	L5	LF*
MA 32 M16 L200S	●	M16	17,0	32	200	10	24	240

## ■ Identification Details

**MA 15 M08 L120 C**

Modular arbor    Shank diameter    Mounting screw    Arbor length    Material  
C: carbide  
S: steel

## ●\* Modular Tool System



## ■ Recommended Tightening Torque

Notes about tightening the head:  
When mounting the head to an arbor, follow the attached tightening torque in the table below.  
Check the mounting screw diameter for the head and arbor beforehand.

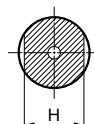
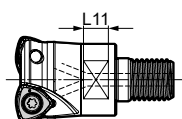



Screw size	Tightening torque	Tool dimensions	
	(N·m)	L11	H
M16	80	10	24

● = Euro stock

○ = Japan stock

## Application Examples

Tool steel X40CrVMo5-1 (45 HRC), mold		Sumitomo	Competitor
	Tool	DMSW08050RS05	Double sided, 6 corners
	Grade	ACU2500	–
	Chipbreaker	G	–
	Cutter diam. (mm)	50	50
	Number of teeth	5	4
	$v_c$ (m/min)	130	130
	$v_f$ (mm/min)	2.500	2.500
	$f_z$ (mm/t)	0,75	0,6
	$a_p$ (mm)	0,5	0,5
	$a_e$ (mm)	35	35
	Coolant	dry	dry
	Results	Minimal damage to insert even after 50 minutes of machining. Stable chip shape.	

Prehardened steel (40 HRC), test piece		Sumitomo	Competitor
	Tool	DMSW08100R06	Double sided, 6 corners
	Grade	ACP3000	–
	Chipbreaker	G	–
	Cutter diam. (mm)	100	100
	Number of teeth	6	6
	$v_c$ (m/min)	180	120
	$v_f$ (mm/min)	5.160	3.440
	$f_z$ (mm/t)	1,5	1,5
	$a_p$ (mm)	1	1
	$a_e$ (mm)	65	65
	Coolant	dry	dry
	Results	No chatter even when the cutting speed is increased at an overhang amount of 380 mm (steel arbor). Efficiency increased 1,5x.	

Tempered steel 42CrMo4 (40 HRC), machine comp.		Sumitomo	Competitor
	Tool	DMSW08050RS04	Single sided, 3 corners
	Grade	ACU2500	–
	Chipbreaker	G	–
	Cutter diam. (mm)	50	50
	Number of teeth	4	4
	$v_c$ (m/min)	210	210
	$v_f$ (mm/min)	5.825	5.825
	$f_z$ (mm/t)	1,1	1,1
	$a_p$ (mm)	1,5	1,5
	$a_e$ (mm)	25	25
	Coolant	dry	dry
	Results	Stable machining without chipping is possible even with heat-treated work material.	

Alloy steel 25CrMo4, large oil drilling tool		Sumitomo	Competitor
	Tool	DMSW08080R08	–
	Grade	ACU2500	–
	Chipbreaker	G	–
	Cutter diam. (mm)	80	–
	Number of teeth	8	–
	$v_c$ (m/min)	180	–
	$v_f$ (mm/min)	3.400	–
	$f_z$ (mm/t)	0,6	–
	$a_p$ (mm)	1,9	–
	$a_e$ (mm)	57	–
	Coolant	dry	–
	Results	Capable of machining single corner of large work piece (nearly 300 minutes). Long tool life.	

Manganese steel construction machine component		Sumitomo	Competitor
	Tool	DMSW08080RS06	Single sided, 2 corners
	Grade	ACU2500	–
	Chipbreaker	G	–
	Cutter diam. (mm)	80	80
	Number of teeth	6	5
	$v_c$ (m/min)	80	80
	$v_f$ (mm/min)	900	900
	$f_z$ (mm/t)	0,47	0,56
	$a_p$ (mm)	1	1
	$a_e$ (mm)	60	60
	Coolant	wet	wet
	Results	Machining without chatter even for castings with low clamp rigidity. Stability with no sudden fractures even in mill-scale work, for a longer tool life (1,3x)	

Alloy steel 15CrMo5, machine component		Sumitomo	Competitor
	Tool	DMSW08125RS08	Double sided, 10 corners
	Grade	ACU2500	–
	Chipbreaker	G	–
	Cutter diam. (mm)	125	125
	Number of teeth	8	13
	$v_c$ (m/min)	280	200
	$v_f$ (mm/min)	4.280	2.185
	$f_z$ (mm/t)	0,75	0,33
	$a_p$ (mm)	1,5	2,0
	$a_e$ (mm)	100	100
	Coolant	wet	wet
	Results	Efficiency improved 1,5x. No sudden fracture. Improved tool life and increased stability.	

Carbon steel C45, large mold part		Sumitomo	Competitor
	Tool	DMSW08050RS05	Single sided, 4 corners
	Grade	ACU2500	–
	Chipbreaker	G	–
	Cutter diam. (mm)	50	50
	Number of teeth	5	5
	$v_c$ (m/min)	189	189
	$v_f$ (mm/min)	5.000	5.000
	$f_z$ (mm/t)	0,83	0,83
	$a_p$ (mm)	1	1
	$a_e$ (mm)	50	50
	Coolant	wet	wet
	Results	Effective without chatter even when using a 200 mm long steel arbor. Achieves roughing (240 min.) of large workpieces without indexing the inserts.	

Low carbon steel SS400, machine component		Sumitomo	Competitor
	Tool	DMSW08040E03	Double sided, 4 corners
	Grade	ACU2500	–
	Chipbreaker	G	–
	Cutter diam. (mm)	40	32
	Number of teeth	3	6
	$v_c$ (m/min)	150	120
	$v_f$ (mm/min)	3.800	3.800
	$f_z$ (mm/t)	1,0	0,5
	$a_p$ (mm)	0,5	0,5
	$a_e$ (mm)	30	30
	Coolant	wet	wet
	Results	2 x tool life.	

## Application Examples

Stainless steel X5CrNiS18 10, machine component		Sumitomo	Competitor
	Vertical 5-axis machining centre BT50		
	Tool	DMSW08080R08	Single sided, 2 corners
	Grade	ACU2500	–
	Chipbreaker	G	–
	Cutter diam. (mm)	80	80
	Number of teeth	8	7
	$v_c$ (m/min)	120	126
	$v_f$ (mm/min)	2.675	490
	$f_z$ (mm/t)	0,7	0,1
	$a_p$ (mm)	1	2
	$a_e$ (mm)	40	40
	Coolant	dry	dry
Results	Efficiency increased 2,7x. Tool life increased 6x or more.		

Gray cast iron GG-25, mold		Sumitomo	Competitor
	Vertical machining centre BT50		
	Tool	DMSW08100R06	Single sided, 4 corners
	Grade	ACP3000	–
	Chipbreaker	G	–
	Cutter diam. (mm)	100	100
	Number of teeth	6	6
	$v_c$ (m/min)	100	100
	$v_f$ (mm/min)	1.910	1.910
	$f_z$ (mm/t)	1	1
	$a_p$ (mm)	1,5	1,5
	$a_e$ (mm)	50	50
	Coolant	wet	wet
Results	Sudden fracture during mill-scale work eliminated. Tool life increased.		

Gray cast iron GG-25, machine component		Sumitomo	Competitor
	Vertical machining centre BT50		
	Tool	DMSW08063R05	Single sided, 3 corners
	Grade	ACU2500	–
	Chipbreaker	G	–
	Cutter diam. (mm)	63	63
	Number of teeth	5	4
	$v_c$ (m/min)	158	158
	$v_f$ (mm/min)	4.000	1.500
	$f_z$ (mm/t)	1,0	0,47
	$a_p$ (mm)	2	1
	$a_e$ (mm)	50	50
	Coolant	dry	dry
Results	Capable of increasing the number of teeth, feed rate and depth of cut. Efficiency increased 5x or more.		

Ductile cast iron FCD540, large mold part		Sumitomo	Competitor
	Horizontal machining centre BT50		
	Tool	DMSW08050RS04	Double sided, 4 corners
	Grade	ACU2500	–
	Chipbreaker	G	–
	Cutter diam. (mm)	50	50
	Number of teeth	4	4
	$v_c$ (m/min)	125	125
	$v_f$ (mm/min)	3.000	3.000
	$f_z$ (mm/t)	1	1
	$a_p$ (mm)	1,5	1,5
	$a_e$ (mm)	25	25
	Coolant	dry	dry
Results	Minimal damage to insert even after 300 minutes of machining.		

Ductile cast iron, machine component		Sumitomo	Competitor
	Vertical 5-axis machining centre BT40		
	Tool	DMSW08050RS05	–
	Grade	ACU2500	–
	Chipbreaker	G	–
	Cutter diam. (mm)	50	–
	Number of teeth	5	–
	$v_c$ (m/min)	210	–
	$v_f$ (mm/min)	5.350	–
	$f_z$ (mm/t)	0,8	–
	$a_p$ (mm)	1	–
	$a_e$ (mm)	30	–
	Coolant	dry	–
Results	Smooth and stable machining even with low-rigidity equipment. Minimal insert damage even after 220 minutes of machining.		

Tool steel X40CrVMo5-1 (48 HRC), forge mold		Sumitomo	Competitor
	Vertical machining centre BT40		
	Tool	DMSW08050RS05	Single sided, 2 corners
	Grade	ACU2500	–
	Chipbreaker	G	–
	Cutter diam. (mm)	50	30
	Number of teeth	5	7
	$v_c$ (m/min)	120	70
	$v_f$ (mm/min)	7.000	3.110
	$f_z$ (mm/t)	1,83	0,6
	$a_p$ (mm)	0,5	0,15
	$a_e$ (mm)	36	22
	Coolant	wet	wet
Results	Larger diameter for increased tool rigidity. Capable of machining at a large single tooth feed rate. Machining time reduced to 1/6.		

Sumi Dual Mill

# DMSW Series



# SUMITOMO

**CARBIDE - CBN - DIAMOND**

(Germany)

SUMITOMO ELECTRIC Hartmetall GmbH  
Konrad-Zuse-Straße 9, 47877 Willich

Tel. +49 2154 4992-0, Fax +49 2154 4992-161  
Info@SumitomoTool.com  
www.SumitomoTool.com



(UK and Ireland)

SUMITOMO ELECTRIC Hardmetal Ltd.  
3 Paper Mill Drive  
Redditch, B98 8QJ, UK

Tel. +44 1844 342081, Fax: +44 1844 342415  
InfoUK@SumitomoTool.com  
www.SumitomoTool.com

