

High-Efficient and High Precision
Tangential Shoulder Milling Cutter

„Sumi Dual Mill“ **TSX Series**

Excellent Surface Finish and Superior Toughness!



"Sumi Dual Mill" Series TSX Type



General Features

High-efficient and high precision tangential shoulder milling cutter with tangential mounted carbide inserts.

Characteristics

Tough & Sharp cutting edge

Tangential mounted carbide insert design and optimized edge geometry realize extremely tough and sharp cutting action.

Very accurate and excellent surface finish



Thanks to newly developed fine carbide press / sintering technology and very accurate grinding techniques, periphery ground inserts generate very accurate and excellent surface finish.

Wide product range

2 different insert size series, 3 chip breaker range and various carbide grade combination offers a wide application range.



Product Range

Shoulder Milling Cutter

Type	Cat. No.	Series	Diameter Range / No of Teeth													Shape		
			Ø16	Ø20	Ø25	Ø32	Ø40	Ø50	Ø63	Ø80	Ø100	Ø125	Ø160	Ø200	Ø250		Ø315	
Shell	TSX 08000RS	Standard Pitch					4	5	6	7								
	TSXF 08000RS	Fine Pitch					6	8	10	11								
	TSX 13000RS	Standard Pitch					3	4	5	5	6	7	8	12	14	16		
	TSXM 13000RS	Medium Pitch					4	5	6	7	8	10	12	16	20	24		
	TSXF 13000RS	Fine Pitch					5	6	7	8	10	14	16					
Shank	TSX 08000E	Standard Pitch	2	2*	3*	3*	4	5	6	7								
	TSXF 08000E	Fine Pitch		3	4	5	6	8	10	11								
	TSX 13000E	Standard Pitch			2	2	3	4	5	5								
	TSXM 13000E	Medium Pitch				3	4	5	6	7								
	TSXF 13000E	Fine Pitch					5	6	7	8								

* Different shank diameters in stock

Repeater

Type	Cat. No.	Diameter Range / No of Teeth										Shape				
		Ø16	Ø20	Ø25	Ø32	Ø40	Ø50	Ø63	Ø80	Ø100	Ø125					
Shell	TSXR 08000RS				2	3	3	4	5							
	TSXR 13000RS					2	3		3	4	4	5	5	6	7	
Shank	TSXR 08000E		1	2	2	3										
	TSXR 13000E					2	3									

Suitable Applications

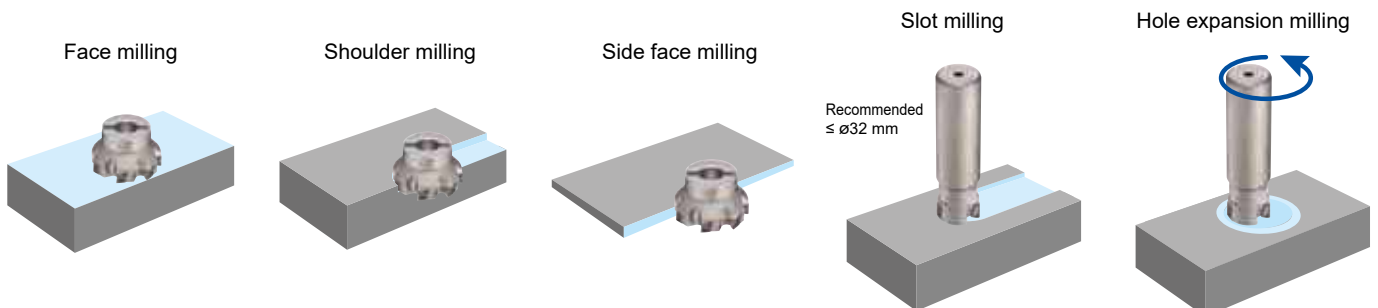

"Sumi Dual Mill" Series TSX Type

■ Insert Grade Selection

We have released:
 ACP100 / ACP200 / ACP300 grades for steel machining,
 ACM200 / ACM300 grades for stainless steel machining and
 ACK200 / ACK300 grades for cast iron machining to cover a wide
 range of work materials.



ISO	Finishing to Light Cut	Medium Cut	Rough to Heavy Cut
P	ACP100		
		ACP200	
			ACP300
M	ACM200		
			ACM300
K	ACK200		
			ACK300
S	ACM200		
			ACM300

PVD
 CVD

■ Chipbreaker Selection

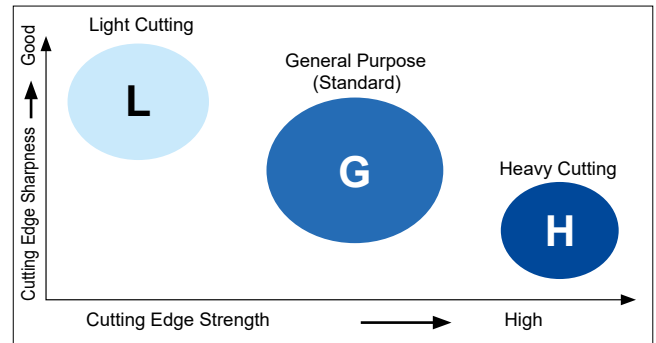

■ Inserts

Cat. No.	R0,4	R0,8	R1,2	R1,6	R2,0	R2,4	R3,2
LNEX0804_ _PNER-L	●	●	○	○			
LNEX0804_ _PNER-G	●	●	●	●			
LNEX1306_ _PNER-L	●	●	○	○	○	○	○
LNEX1306_ _PNER-G	○	●	○	●	●	●	●
LNEX1306_ _PNER-H	●	●	○	●	●	●	●

■ Chipbreaker Selection

Work Material	P M K S		
	L type	G type	H type
Chipbreaker			
Feature	Low cutting force	General purpose	Strong edge
LNEX08 Cutting edge geometry			—
LNEX13 Cutting edge geometry			
Application	Light cut, low rigidity milling and reduced burrs	Main breaker for general purpose applications	Roughing, heavy interrupted and hardness steel milling

"Sumi Dual Mill" Series TSX Type

Toughness

TSX type has extremely stable cutting edge.

Cutting Length	4 Passes	8 Passes	12 Passes
TSX	Available		
Competitor A	Breakage		
Competitor B	Breakage		

Machine:	M/C BT-50, vertical	Work Material:	C50
Tool:	TSX13100RS	Insert:	LNEX130608PNER-G (ACP200)
Cutting Conditions:			
$v_c = 150$ m/min, $f_z = 0,6$ mm/t, $a_p = 3$ mm, $a_e = 40$ mm, dry			

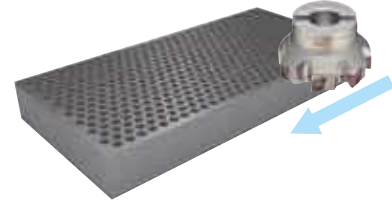

Squareness of Machined Shoulder

TSX type shows excellent squareness due to ground insert and optimized design.

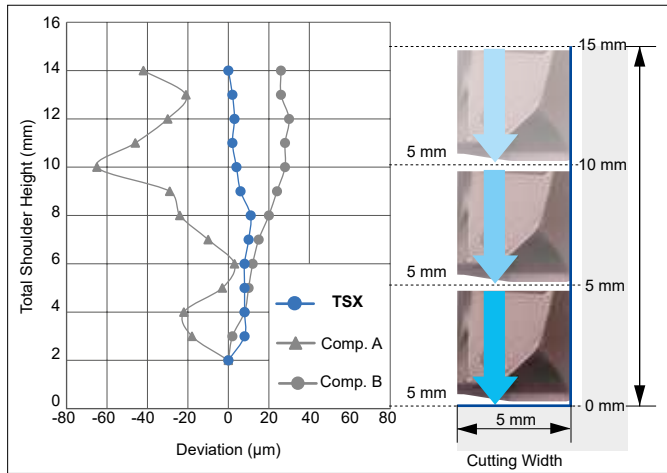

Machine:	M/C BT-50, vertical	Work Material:	Carbon Steel
Tool:	TSX13100RS	Insert:	LNEX130608PNER-G (ACP200)
Cutting Conditions:			
$v_c = 200$ m/min, $f_z = 0,2$ mm/t, $a_p = 5$ mm x 3 passes, $a_e = 5$ mm, dry			

Surface Finish

TSX type shows excellent surface roughness.

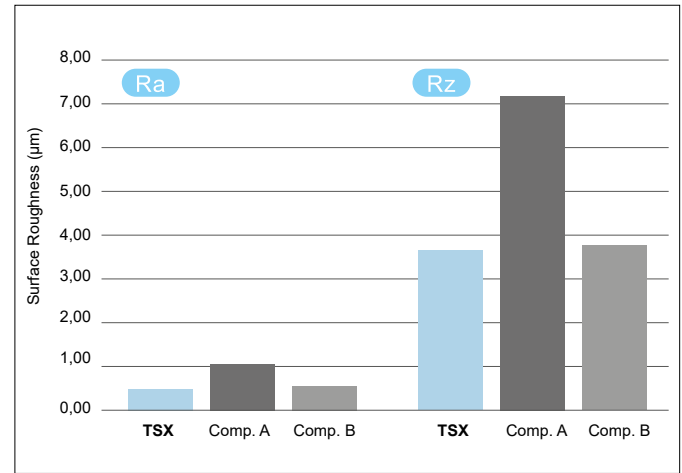

Machine:	M/C BT-50, vertical	Work Material:	C50
Tool:	TSX13100RS	Insert:	LNEX130608PNER-G (ACP200)
Cutting Conditions:			
$v_c = 200$ m/min, $f_z = 0,2$ mm/t, $a_p = 3$ mm, $a_e = 60$ mm, dry			

Tool Life

Longer tool life and stability due to superior wear resistance.

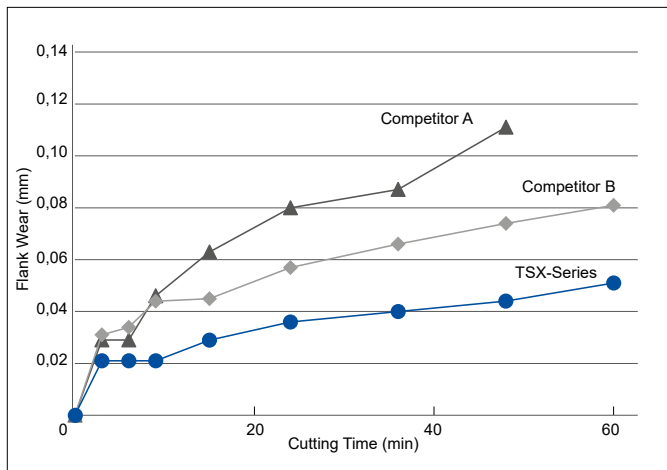

Machine:	M/C BT-50, vertical	Work Material:	C50
Tool:	TSX08025E	Insert:	LNEX080408PNER-G (ACP200)
Cutting Conditions:			
$v_c = 200$ m/min, $f_z = 0,10$ mm/t, $a_p = 2$ mm, $a_e = 5$ mm			

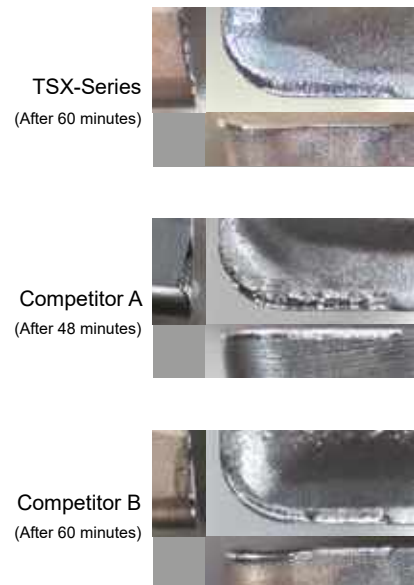

"Sumi Dual Mill" Series TSX Type

Shoulder Milling Tool Selection Guide

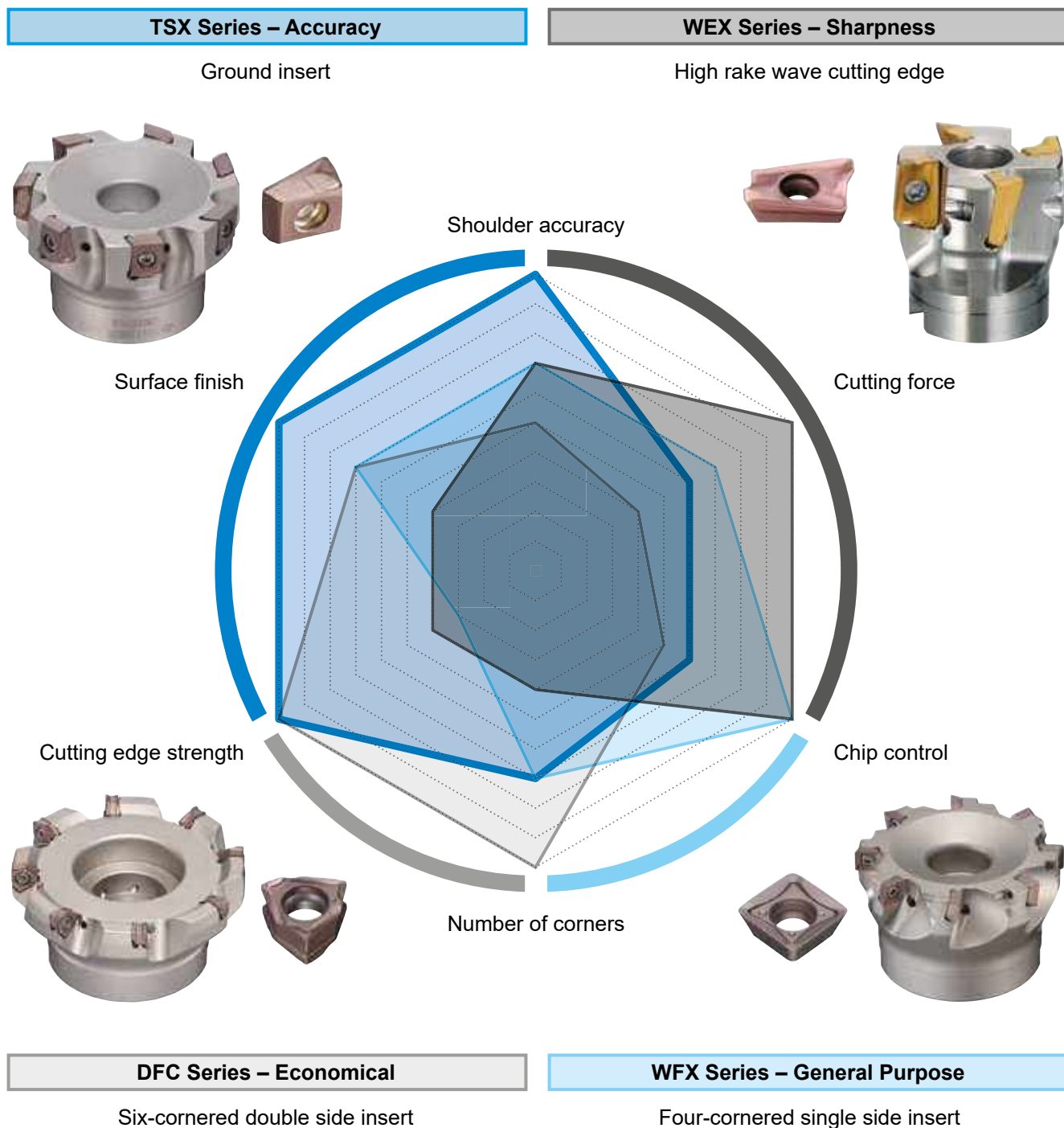

★★★ Top recommendation

	Surface Finish	Shoulder Accuracy	Cutting Force	Chip Control	Number of Corners	Cutting edge Strength
TSX Series	★★★	★★★	★★	★☆	★★	★★★
DFC Series	★★	★	★	★☆	★★★	★★★
WEX Series	★	★★	★★★	★★★	★	★★
WFX Series	★★	★★	★★	★★★	★★	★

"Sumi Dual Mill" Series TSX(F) 08000 RS

Shell Type

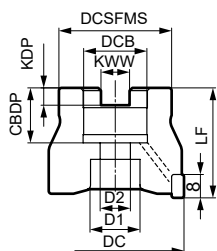

Rake Angle	Radial	-20°	8 mm	90°
	Axial	-6°		

Body - TSX, Standard Pitch

Cat. No.	Stock	Dimensions (mm)										No. of Teeth	Weight (kg)
		DC	DCSFMS	LF	DCB	KWW	KDP	CBDP	D1	D2			
TSX 08040 RS	●	40	33	40	16	8,4	5,6	18	14	9	4	0,21	
08050 RS	●	50	41	40	22	10,4	6,3	20	18	11	5	0,30	
08063 RS	●	63	50	40	22	10,4	6,3	20	18	11	6	0,53	
08080 RS	○	80*	55	50	27	12,4	7,0	22	20	14	7	0,99	

Check the arbor attachment size (DCB) when selecting the cutter. Inserts are not included.
* Please use JIS B1176 hexagonal bolt (M12x30 to 35 mm) for securing a Ø 80 mm cutter to the arbor.

Body - TSXF, Fine Pitch

Cat. No.	Stock	Dimensions (mm)										No. of Teeth	Weight (kg)
		DC	DCSFMS	LF	DCB	KWW	KDP	CBDP	D1	D2			
TSXF 08040 RS	●	40	33	40	16	8,4	5,6	18	14	9	6	0,21	
08050 RS	●	50	41	40	22	10,4	6,3	20	18	11	8	0,31	
08063 RS	●	63	50	40	22	10,4	6,3	20	18	11	10	0,54	
08080 RS	○	80*	55	50	27	12,4	7,0	22	20	14	11	0,97	

Check the arbor attachment size (DCB) when selecting the cutter. Inserts are not included.
* Please use JIS B1176 hexagonal bolt (M12x30 to 35 mm) for securing a Ø 80 mm cutter to the arbor.

Inserts

Application	Grade	Coated Carbide						P	Steel
	High Speed / Light Cutting	AC	AC	AC	AC	AC	AC	M	Stainless Steel
Application	General Purpose Cutting	AC	AC	AC	AC	AC	AC	K	Cast Iron
	Rough Cutting	AC	AC	AC	AC	AC	AC	S	Exotic Alloy
Cat. No.	ACP100	ACP200	ACP300	ACK200	ACK300	ACM200	ACM300	Radius	
	RE								
LNEX 080404 PNER-L	○	○	○	○	○	○	○	0,4	
080408 PNER-L	●	○	○	○	○	○	○	0,8	
080412 PNER-L	○	○	○	○	○	○	○	1,2	
080416 PNER-L	○	○	○	○	○	○	○	1,6	
LNEX 080404 PNER-G	○	●	●	●	●	●	●	0,4	
080408 PNER-G	●	●	●	●	●	●	●	0,8	
080412 PNER-G	○	●	●	●	●	●	●	1,2	
080416 PNER-G	○	●	●	●	●	●	●	1,6	

Recommended Cutting Conditions

Min. - Optimum - Max.

ISO	Work-material	Hardness	Cutting Speed v_c (m/min)	TSX 08000	TSX 13000	Grade
				Feed Rate f_t (mm/T)	Feed Rate f_t (mm/T)	
P	Carbon Steel	180–280HB	150–225–300	0,08–0,20–0,30	0,10–0,30–0,40	ACP100 ACP200 ACP300
		> 280HB	75–150–230	0,08–0,20–0,30	0,10–0,30–0,40	
	Alloy Steel	180–280HB	100–175–250	0,08–0,15–0,25	0,10–0,25–0,35	
M	Stainless Steel	220–280HB	90–135–180	0,08–0,15–0,25	0,10–0,20–0,30	ACM200 ACM300
		>280HB	75–125–170	0,08–0,15–0,25	0,10–0,20–0,30	
K	Cast Iron Ductile Cast Iron	250HB	100–175–250	0,08–0,20–0,30	0,10–0,30–0,40	ACK200 ACK300
S	Exotic Material	–	30–60–90	0,05–0,10–0,15	0,05–0,15–0,20	ACM200 ACM300

Identification Details

TSX	F	08	050	R	S
Cutter Series	F: Fine Pitch	Insert Size	Cutter Diameter	Direction	Metric Type

Spare Parts

Screw	Wrench
BFTX0308IP	TRDR08IP
	2,0

● = Euro stock

○ = Japan stock

"Sumi Dual Mill" Series TSX 13000 RS

Shell Type



Fig. 1

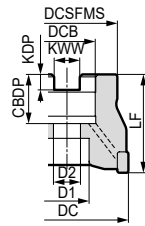

Fig. 2

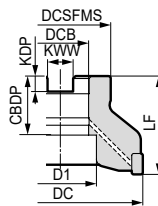
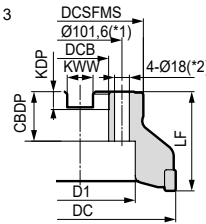
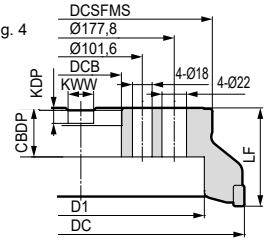

Fig. 3



In case of TSX 13160RS
*1: Ø 66,7 / *2: 4-Ø 14

Fig. 4



Rake Angle	Radial	-23° - -15°	12 mm	90°
	Axial	-6°		

Body - TSX, Standard Pitch

Cat. No.	Stock	Dimensions (mm)									No. of Teeth	Weight (kg)	Figure
		DC	DCSFMS	LF	DCB	KWW	KDP	CBDP	D1	D2			
TSX 13040 RS	●	40	33	40	16	8,4	5,6	18	14	9	3	0,20	1
13050 RS	●	50	41	40	22	10,4	6,3	20	18	11	4	0,30	1
13063 RS	●	63	50	40	22	10,4	6,3	20	18	11	5	0,50	1
13080 RS	●	80*	55	50	27	12,4	7,0	22	20	14	5	0,92	1
13100 RS	●	100*	70	50	32	14,4	8,0	32	46	-	6	1,35	2
13125 RS	●	125	80	63	40	16,4	9,0	29	52	29	7	2,55	1
13160 RS	●	160	130	63	40	16,4	9,0	29	90	-	8	4,97	3*
13200 RS	○	200	160	63	60	25,7	14,0	35	135	-	12	6,20	3
13250 RS	○	250	180	63	60	25,7	14,0	35	160	-	14	9,35	3
13315 RS	○	315	240	63	60	25,7	14,0	35	230	-	16	16,42	4

Check the arbor attachment size (DCB) when selecting the cutter. Inserts are not included.
*Please use JIS B1176 hexagonal bolt (Ø 80: M12x30 to 35 mm, Ø 100: M16 x 40 to 45 mm) for securing Ø 80 / Ø 100 cutter on the arbor.

Inserts

Grade		Coated Carbide						P	Steel
Application	High Speed / Light Cutting							M	Stainless Steel
	General Purpose Cutting							K	Cast Iron
	Rough Cutting							S	Exotic Alloy
Cat. No.	ACP100	ACP200	ACP300	ACK200	ACK300	ACM200	ACM300	Radius	RE
LNEX 130604 PNER-L	●	○	○	○	○	○	○	0,4	
130608 PNER-L	●	○	○	○	○	○	○	0,8	
130612 PNER-L	●	○	○	○	○	○	○	1,2	
130616 PNER-L	○	○	○	○	○	○	○	1,6	
130620 PNER-L	○	○	○	○	○	○	○	2,0	
130624 PNER-L	○	○	○	○	○	○	○	2,4	
130632 PNER-L	○	○	○	○	○	○	○	3,2	
LNEX 130604 PNER-G	○	●	●	●	●	●	●	0,4	
130608 PNER-G	○	●	●	●	●	●	●	0,8	
130612 PNER-G	○	●	●	●	●	●	●	1,2	
130616 PNER-G	○	○	○	○	○	○	○	1,6	
130620 PNER-G	○	○	○	○	○	○	○	2,0	
130624 PNER-G	○	○	○	○	○	○	○	2,4	
130632 PNER-G	○	○	○	○	○	○	○	3,2	
LNEX 130604 PNER-H		○	○	○	○			0,4	
130608 PNER-H		○	○	○	○			0,8	
130612 PNER-H		○	○	○	○			1,2	
130616 PNER-H		○	○	○	○			1,6	
130620 PNER-H		○	○	○	○			2,0	
130624 PNER-H		○	○	○	○			2,4	
130632 PNER-H		○	○	○	○			3,2	

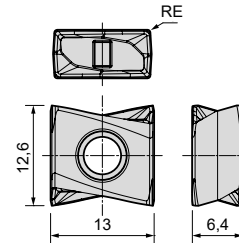

Recommended Cutting Conditions



Identification Details

TSX	13	100	R	S
Cutter Series	Insert Size	Cutter Diameter	Direction	Metric Type

Spare Parts

Screw	Wrench
BFTX03510IP	TRDR15IP

"Sumi Dual Mill" Series TSXM 13000 RS

Shell Type

Rake Angle	Radial	-23° ~ -15°	12 mm	90°
	Axial	-6°		



Fig. 1

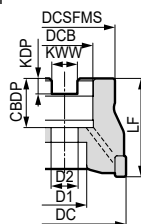

Fig. 2

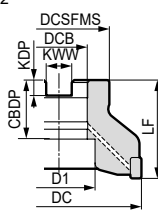
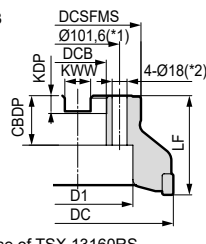
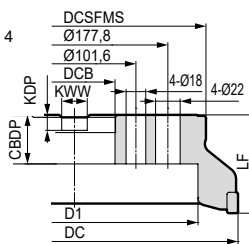

Fig. 3



In case of TSX 13160RS
*1: Ø66,7 / *2: 4-Ø14

Fig. 4



Body - TSXM, Medium Pitch

Cat. No.	Stock	Dimensions (mm)									No. of Teeth	Weight (kg)	Figure
		DC	DCSFMS	LF	DCB	KWW	KDP	CBDP	D1	D2			
TSXM 13040 RS	●	40	33	40	16	8,4	5,6	18	14	9	4	0,19	1
13050 RS	●	50	41	40	22	10,4	6,3	20	18	11	5	0,28	1
13063 RS	●	63	50	40	22	10,4	6,3	20	18	11	6	0,50	1
13080 RS	●	80*	55	50	27	12,4	7,0	22	20	14	7	0,92	1
13100 RS	●	100*	70	50	32	14,4	8,0	32	46	-	8	1,36	2
13125 RS	●	125	80	63	40	16,4	9,0	29	52	29	10	2,57	1
13160 RS	●	160	130	63	40	16,4	9,0	29	90	-	12	5,02	3*
13200 RS	○	200	160	63	60	25,7	14,0	35	135	-	16	6,32	3
13250 RS	○	250	180	63	60	25,7	14,0	35	160	-	20	9,42	3
13315 RS	○	315	240	63	60	25,7	14,0	35	230	-	24	16,37	4

Check the arbor attachment size (DCB) when selecting the cutter. Inserts are not included.
*Please use JIS B1176 hexagonal bolt (Ø 80: M12x30 to 35 mm, Ø 100: M16 x 40 to 45 mm) for securing Ø 80 / Ø 100 cutter on the arbor.

Inserts

Grade		Coated Carbide						P	Steel
Application	High Speed / Light Cutting	P		K	M			M	Stainless Steel
	General Purpose Cutting	P		K	M	S		K	Cast Iron
	Rough Cutting			K	M	S		S	Exotic Alloy
Cat. No.							Radius		
	ACP100	ACP200	ACP300	ACK200	ACK300	ACM200	ACM300	RE	
LNEX 130604 PNER-L	●	○	○	○	●	○	○	0,4	
130608 PNER-L	●	○	○	○	●	○	○	0,8	
130612 PNER-L	●	○	○	○	●	○	○	1,2	
130616 PNER-L	○	○	○	○	○	○	○	1,6	
130620 PNER-L	○	○	○	○	○	○	○	2,0	
130624 PNER-L	○	○	○	○	○	○	○	2,4	
130632 PNER-L	○	○	○	○	○	○	○	3,2	
LNEX 130604 PNER-G	○	●	●	●	●	○	○	0,4	
130608 PNER-G	○	●	●	●	●	○	○	0,8	
130612 PNER-G	○	●	●	●	●	○	○	1,2	
130616 PNER-G	○	○	○	○	○	○	○	1,6	
130620 PNER-G	○	○	○	○	○	○	○	2,0	
130624 PNER-G	○	○	○	○	○	○	○	2,4	
130632 PNER-G	○	○	○	○	○	○	○	3,2	
LNEX 130604 PNER-H	○	○	○	○	○	○	○	0,4	
130608 PNER-H	○	○	○	○	○	○	○	0,8	
130612 PNER-H	○	○	○	○	○	○	○	1,2	
130616 PNER-H	○	○	○	○	○	○	○	1,6	
130620 PNER-H	○	○	○	○	○	○	○	2,0	
130624 PNER-H	○	○	○	○	○	○	○	2,4	
130632 PNER-H	○	○	○	○	○	○	○	3,2	

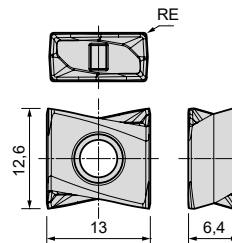

Recommended Cutting Conditions



Identification Details

TSX	M	13	100	R	S
Cutter Series	M: Medium Pitch	Insert Size	Cutter Diameter	Direction	Metric Type

Spare Parts

Screw	Wrench
BFTX03510IP	TRDR15IP

● = Euro stock

○ = Japan stock

"Sumi Dual Mill" Series TSXF 13000 RS

Shell Type



Fig. 1

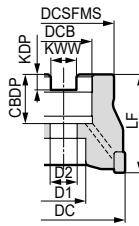

Fig. 2

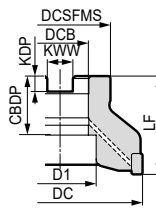
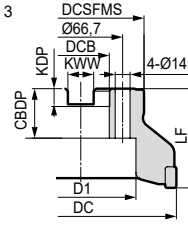

Fig. 3



Rake Angle	Radial	-23° - -15°	12 mm	90°
	Axial	-6°		

Body - TSXF, Fine Pitch

Cat. No.	Stock	Dimensions (mm)									No. of Teeth	Weight (kg)	Figure
		DC	DCSFMS	LF	DCB	KWW	KDP	CBDP	D1	D2			
TSXF 13040 RS	○	40	33	40	16	8,4	5,6	18	14	9	5	0,18	1
13050 RS	○	50	41	40	22	10,4	6,3	20	18	11	6	0,29	1
13063 RS	○	63	50	40	22	10,4	6,3	20	18	11	7	0,50	1
13080 RS	○	80*	55	50	27	12,4	7,0	22	20	14	8	0,92	1
13100 RS	○	100*	70	50	32	14,4	8,0	32	46	—	10	1,34	2
13125 RS	○	125	80	63	40	16,4	9,0	29	52	29	14	2,58	1
13160 RS	○	160	130	63	40	16,4	9,0	29	90	—	16	5,08	3

Check the arbor attachment size (DCB) when selecting the cutter. Inserts are not included.
*Please use JIS B1176 hexagonal bolt (Ø 80: M12x30 to 35 mm, Ø 100: M16 x 40 to 45 mm) for securing Ø 80 / Ø 100 cutter on the arbor.

Inserts

Grade		Coated Carbide						P	Steel
Application	High Speed / Light Cutting								Stainless Steel
	General Purpose Cutting								Cast Iron
	Rough Cutting								Exotic Alloy
Cat. No.							Radius		
	ACP100	ACP200	ACP300	ACK200	ACK300	ACM200	ACM300	RE	
LNEX 130604 PNER-L	●	○	○	○	○	○	○	0,4	
130608 PNER-L	●	○	○	○	○	○	○	0,8	
130612 PNER-L	●	○	○	○	○	○	○	1,2	
130616 PNER-L	○	○	○	○	○	○	○	1,6	
130620 PNER-L	○	○	○	○	○	○	○	2,0	
130624 PNER-L	○	○	○	○	○	○	○	2,4	
130632 PNER-L	○	○	○	○	○	○	○	3,2	
LNEX 130604 PNER-G	○	●	●	●	●	○	○	0,4	
130608 PNER-G	○	●	●	●	●	○	○	0,8	
130612 PNER-G	○	●	●	●	●	○	○	1,2	
130616 PNER-G	○	○	○	○	○	○	○	1,6	
130620 PNER-G	○	○	○	○	○	○	○	2,0	
130624 PNER-G	○	○	○	○	○	○	○	2,4	
130632 PNER-G	○	○	○	○	○	○	○	3,2	
LNEX 130604 PNER-H		○	○	○	○			0,4	
130608 PNER-H		○	○	○	○			0,8	
130612 PNER-H		○	○	○	○			1,2	
130616 PNER-H		○	○	○	○			1,6	
130620 PNER-H		○	○	○	○			2,0	
130624 PNER-H		○	○	○	○			2,4	
130632 PNER-H		○	○	○	○			3,2	

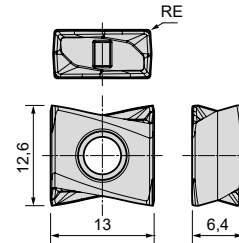

Recommended Cutting Conditions



Identification Details

TSX	F	13	100	R	S
Cutter Series	F: Fine Pitch	Insert Size	Cutter Diameter	Direction	Metric Type

Spare Parts

Screw	Wrench
BFTX03510IP	TRDR15IP
3,0	

"Sumi Dual Mill" Series TSX(F) 08000 E

Shank Type

Rake Angle	Radial	-36° ~ -20°	8 mm	90°
	Axial	-6°		

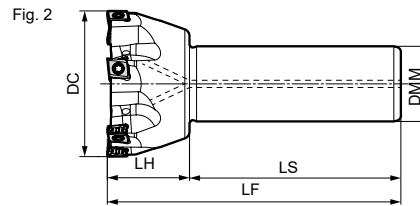
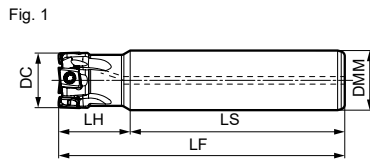

Body - TSX, Standard Pitch

Cat. No.	Stock	Dimensions (mm)					No. of Teeth	Weight (kg)	Figure
		DC	DMM	LH	LS	LF			
TSX 08016 E	●	16	16	25	75	100	2	0,13	1
08020 E	●	20	20	30	80	110	2	0,22	1
08020 E-16	○	20	16	30	80	110	2	0,15	2
08025 E	●	25	25	30	90	120	3	0,40	1
08025 E-20	○	25	20	30	90	120	3	0,26	2
08032 E	●	32	32	30	90	120	3	0,67	1
08032 E-25	○	32	25	30	90	120	3	0,43	2
08040 E	●	40	32	30	90	120	4	0,72	2
08050 E	○	50	32	30	90	120	5	0,85	2
08063 E	○	63	32	35	90	125	6	1,09	2
08080 E	○	80	32	35	90	125	7	1,44	2

Inserts are not included.

Body - TSXF, Fine Pitch

Cat. No.	Stock	Dimensions (mm)					No. of Teeth	Weight (kg)	Figure
		DC	DMM	LH	LS	LF			
TSXF 08020 E	●	20	20	30	80	110	3	0,22	1
08025 E	●	25	25	30	90	120	4	0,40	1
08032 E	●	32	32	30	90	120	5	0,67	1
08040 E	●	40	32	30	90	120	6	0,73	2
08050 E	○	50	32	30	90	120	8	0,85	2
08063 E	○	63	32	35	90	125	10	1,10	2
08080 E	○	80	32	35	90	125	11	1,42	2

Inserts are not included.

Inserts

Grade		Coated Carbide						P	Steel
Application	High Speed / Light Cutting	P		K	M	S		M	Stainless Steel
	General Purpose Cutting	P		K	M	S		K	Cast Iron
	Rough Cutting			K	M	S		S	Exotic Alloy
Cat. No.							Radius		
	ACP100	ACP200	ACP300	ACK200	ACK300	ACM200	ACM300	RE	
LNEX 080404 PNER-L	●	○	○	○	○	○	○	0,4	
080408 PNER-L	○	○	○	○	○	○	○	0,8	
080412 PNER-L	○	○	○	○	○	○	○	1,2	
080416 PNER-L	○	○	○	○	○	○	○	1,6	
LNEX 080404 PNER-G	○	●	●	●	●	●	●	0,4	
080408 PNER-G	○	●	●	●	●	●	●	0,8	
080412 PNER-G	○	●	●	●	●	○	●	1,2	
080416 PNER-G	○	●	●	●	●	○	●	1,6	

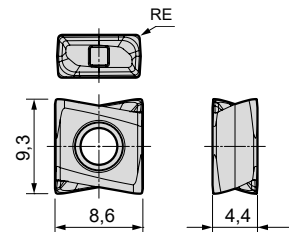

Recommended Cutting Conditions



Identification Details

TSX	F/M	08	032	E
Cutter Series	F: Fine Pitch M: Medium Pitch	Insert Size	Cutter Diameter	Endmill Type

Spare Parts

Insert Screw	Insert Wrench	Applicable Cutters
BFTX0306IP BFTX0308IP	TRDR08IP	

"Sumi Dual Mill" Series TSX(M/F) 13000 E

Shank Type

Rake Angle	Radial	-31° - -15°	12 mm	90°
	Axial	-6°		



Fig. 1

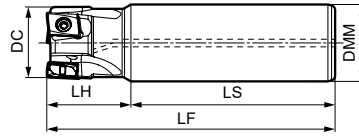
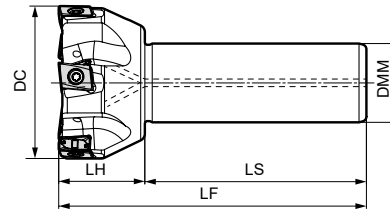

Fig. 2



Body - TSX, Standard Pitch

Cat. No.	Stock	Dimensions (mm)					No. of Teeth	Weight (kg)	Figure
		DC	DMM	LH	LS	LF			
TSX 13025 E	●	25	25	35	85	120	2	0,38	1
13032 E	●	32	32	35	85	120	2	0,66	1
13040 E	●	40	32	30	90	120	3	0,71	2
13050 E	●	50	32	30	90	120	4	0,81	2
13063 E	○	63	32	35	90	125	5	1,08	2
13080 E	○	80	32	35	90	125	5	1,40	2

Inserts are not included.

Body - TSXM, Medium Pitch

Cat. No.	Stock	Dimensions (mm)					No. of Teeth	Weight (kg)	Figure
		DC	DMM	LH	LS	LF			
TSXM 13032 E	●	32	32	35	85	120	3	0,35	1
13040 E	●	40	32	30	90	120	4	0,71	2
13050 E	●	50	32	30	90	120	5	0,80	2
13063 E	○	63	32	35	90	125	6	1,07	2
13080 E	○	80	32	35	90	125	7	1,41	2

Inserts are not included.

Body - TSXF, Fine Pitch

Cat. No.	Stock	Dimensions (mm)					No. of Teeth	Weight (kg)	Figure
		DC	DMM	LH	LS	LF			
TSXF 13040 E	○	40	32	30	90	120	5	0,70	2
13050 E	○	50	32	30	90	120	6	0,80	2
13063 E	○	63	32	30	90	125	7	1,07	2
13080 E	○	80	32	35	90	125	8	1,42	2

Inserts are not included.

Inserts

Grade	Coated Carbide						P	Steel
	M	K	M	M	M	M	M	Stainless Steel
Application High Speed / Light Cutting	M	K	M	M	M	M	M	Cast Iron
General Purpose Cutting	M	K	M	M	M	M	M	Exotic Alloy
Rough Cutting								
Cat. No.	ACP100	ACP200	ACP300	ACK200	ACK300	ACM200	ACM300	Radius
								RE
LNEX 130604 PNER-L	●	○	○	○	○	○	○	0,4
130608 PNER-L	●	○	○	○	○	○	○	0,8
130612 PNER-L	●	○	○	○	○	○	○	1,2
130616 PNER-L	○	○	○	○	○	○	○	1,6
130620 PNER-L	○	○	○	○	○	○	○	2,0
130624 PNER-L	○	○	○	○	○	○	○	2,4
130632 PNER-L	○	○	○	○	○	○	○	3,2
LNEX 130604 PNER-G	○	●	●	●	●	●	●	0,4
130608 PNER-G	○	●	●	●	●	●	●	0,8
130612 PNER-G	○	●	●	●	●	●	●	1,2
130616 PNER-G	○	○	○	○	○	○	○	1,6
130620 PNER-G	○	○	○	○	○	○	○	2,0
130624 PNER-G	○	○	○	○	○	○	○	2,4
130632 PNER-G	○	○	○	○	○	○	○	3,2
LNEX 130604 PNER-H	○	○	○	○	○	○	○	0,4
130608 PNER-H	○	●	●	●	●	●	●	0,8
130612 PNER-H	○	●	●	●	●	●	●	1,2
130616 PNER-H	○	○	○	○	○	○	○	1,6
130620 PNER-H	○	○	○	○	○	○	○	2,0
130624 PNER-H	○	○	○	○	○	○	○	2,4
130632 PNER-H	○	○	○	○	○	○	○	3,2

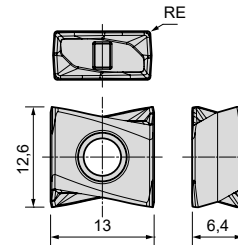

Recommended Cutting Conditions

P6

Spare Parts

Insert Screw	Insert Wrench
BFTX03510IP	TRDR15IP
3,0	

Identification Details

P10

● = Euro stock

○ = Japan stock

"Sumi Dual Mill" Series TSXR 08000 RS

Shell Type

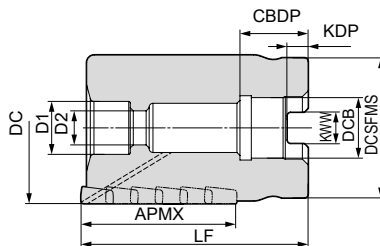

Rake Angle	Radial	-20° - -15°	34-60 mm	90°
	Axial	-6° - -3°		

Body - TSXR

Cat. No.	Stock	Dimensions (mm)										No. of Teeth	Steps	Effective Teeth
		DC	APMX	DCSFMS	LF	DCB	KWW	KDP	CDBP	D1	D2			
TSXR 08032RS3416Z02	○	32	34	33	55	16,0	8,4	5,6	18,0	14	9	10	5	2
08040RS4016Z03	○	40	40	37	60	16,0	8,4	5,6	18,0	14	9	18	6	3
08050RS5422Z03	○	50	54	47	75	22,0	10,4	6,3	20,0	18	11	24	8	3
08050RS5422Z04	○	50	54	47	75	22,0	10,4	6,3	20,0	18	11	32	8	4
08063RS6027Z05	○	63	60	60	80	27,0	12,4	7,0	22,0	20	14	45	9	5

Inserts are not included.

Inserts

Application	Grade		Coated Carbide						P Steel	
	High Speed / Light Cutting								M	Stainless Steel
	General Purpose Cutting								K	Cast Iron
	Rough Cutting								S	Exotic Alloy
Cat. No.		ACP100	ACP200	ACP300	ACK200	ACK300	ACM200	ACM300	Radius	
									RE	RE
LNEX 080404 PNER-L		●	○	○	○	○	○	○	0,4	
080408 PNER-L		●	○	○	○	○	○	○	0,8	
080412 PNER-L		○	○	○	○	○	○	○	1,2	
080416 PNER-L		○	○	○	○	○	○	○	1,6	
LNEX 080404 PNER-G		○	●	●	●	●	○	●	0,4	
080408 PNER-G		○	●	●	●	●	○	●	0,8	
080412 PNER-G		○	○	○	○	○	○	○	1,2	
080416 PNER-G		○	●	●	●	●	○	●	1,6	

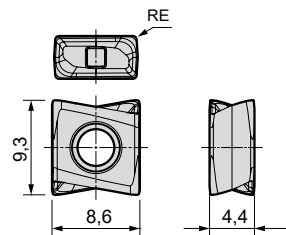

Recommended Cutting Conditions

Min. - Optimum - Max.

ISO	Work-material	Hardness	Cutting Speed v_c (m/min)	Feed Rate f_t (mm/T)	Grade
P	Carbon Steel	180-280HB	110-200-280	0,10-0,20-0,30	ACP100 ACP200 ACP300
		> 280HB	70-135-200	0,10-0,20-0,30	
	Alloy Steel	180-280HB	90-155-220	0,10-0,15-0,25	
M	Stainless Steel	220-280HB	90-135-180	0,10-0,15-0,25	ACM200 ACM300
		>280HB	70-115-160	0,10-0,15-0,25	
K	Cast Iron Ductile Cast Iron	250HB	125-175-225	0,10-0,20-0,30	ACK200 ACK300
S	Exotic Material	-	30-60-90	0,05-0,10-0,15	ACM200 ACM300

Identification Details

TSXR 08 050 R S 54 22 Z03

Cutter Series Insert Size Cutter Diameter Direction Metric Type Max. Depth of Cut Bore Diameter Effective Teeth

Spare Parts

Applicable Cutters	Insert Wrench	Insert Screw	Bolt
TSXR 08032RS3416Z02 TSXR 08040RS4016Z03 TSXR 08050RS5422Z03 TSXR 08050RS5422Z04 TSXR 08063RS6027Z05			
TRDR08IP	BFTX0308IP	2,0	BX0845 BX0850 BX1060 BX1265

● = Euro stock

○ = Japan stock

"Sumi Dual Mill" Series TSXR 13000 RS

Shell Type

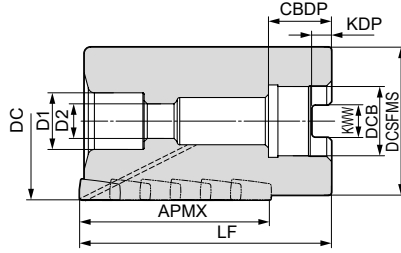

Rake Angle	Radial	-23° - -15°	41-60 mm	90°
	Axial	-6° - -3°		

Body - TSXR

Cat. No.	Stock	Dimensions (mm)										No. of Teeth	Steps	Effective Teeth
		DC	APMX	DCSFMS	LF	DCB	KWW	KDP	CBDP	D1	D2			
TSXR 13040RS4116Z02	○	40	41	37	60	16,0	8,4	5,6	18,0	14	9	8	4	2
13050RS6022Z03	○	50	60	47	80	22,0	10,4	6,3	20,0	18	11	18	6	3
13063RS5027Z03	○	63	50	60	75	27,0	12,4	7,0	22,0	20	14	15	5	3
13063RS6027Z04	○	63	60	60	80	27,0	12,4	7,0	22,0	20	14	24	6	4
13080RS6032Z04	○	80	60	77	80	32,0	14,4	8,0	32,0	25	18	24	6	4
13080RS6032Z05	○	80	60	77	80	32,0	14,4	8,0	32,0	25	18	30	6	5
13100RS6040Z05	○	100	60	88	85	40,0	16,4	9,0	29,0	32	21	30	6	5
13100RS6040Z06	○	100	60	88	85	40,0	16,4	9,0	29,0	32	21	36	6	6
13125RS6040Z07	○	125	60	100	85	40,0	16,4	9,0	29,0	32	21	42	6	7

Inserts are not included.

Inserts

Grade		Coated Carbide						P	Steel
Application	High Speed / Light Cutting							M	Stainless Steel
	General Purpose Cutting							K	Cast Iron
	Rough Cutting							S	Exotic Alloy
Cat. No.		ACP100	ACP200	ACP300	ACK200	ACK300	ACM200	ACM300	Radius
									RE
LNEX 130604 PNER-L		●	○	○	○	○	○	○	0,4
130608 PNER-L		●	○	○	○	○	○	○	0,8
130612 PNER-L		●	○	○	○	○	○	○	1,2
130616 PNER-L		○	○	○	○	○	○	○	1,6
130620 PNER-L		○	○	○	○	○	○	○	2,0
130624 PNER-L		○	○	○	○	○	○	○	2,4
130632 PNER-L		○	○	○	○	○	○	○	3,2
LNEX 130604 PNER-G		○	●	●	●	●	○	○	0,4
130608 PNER-G		●	●	●	●	●	●	○	0,8
130612 PNER-G		●	●	●	●	●	●	○	1,2
130616 PNER-G		○	●	●	●	●	○	○	1,6
130620 PNER-G		○	○	○	○	○	○	○	2,0
130624 PNER-G		○	●	●	●	●	○	○	2,4
130632 PNER-G		○	●	●	●	●	○	○	3,2
LNEX 130604 PNER-H		○	○	○	○	○	○	○	0,4
130608 PNER-H		●	●	●	●	●	○	○	0,8
130612 PNER-H		●	●	●	●	●	○	○	1,2
130616 PNER-H		○	○	○	○	○	○	○	1,6
130620 PNER-H		○	○	○	○	○	○	○	2,0
130624 PNER-H		●	●	●	●	●	○	○	2,4
130632 PNER-H		●	●	●	●	●	○	○	3,2

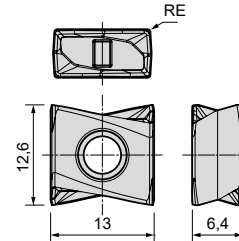

Recommended Cutting Conditions

P12

Identification Details

TSXR 13 050 R S 60 22 Z03

Cutter Series	Insert Size	Cutter Diameter	Direction	Metric Type	Max. Depth of Cut	Bore Diameter	Effective Teeth
TSXR	13	050	R	S	60	22	Z03

Spare Parts

Applicable Cutters	Insert Wrench	Insert Screw	Bolt
TSXR 13040RS4116Z02 TSXR 13050RS6022Z03 TSXR 13063RS5027Z03 TSXR 13063RS6027Z04 TSXR 13080RS6032Z04 TSXR 13080RS6032Z05 TSXR 13100RS6040Z05 TSXR 13100RS6040Z06 TSXR 13125RS6040Z07			
	TRDR15IP	BFTX03510IP	3,0
			BX0850 BX1060 BX1260 BX1265 BX1660 BX2065

● = Euro stock

○ = Japan stock

"Sumi Dual Mill" Series TSXR 08000 E

Shank Type

Rake Angle	Radial	-33° - -18°	21-40 mm	90°
	Axial	-6° - -3°		

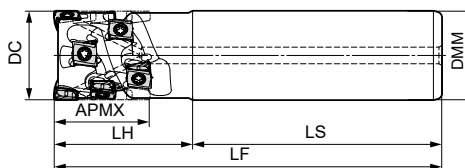

Body - TSXR

Cat. No.	Stock	Dimensions (mm)						No. of Teeth	Steps	Effective Teeth
		DC	APMX	DMM	LH	LS	LF			
TSXR 08020E2120Z01	○	20	21	20	30	80	110	3	3	1
08025E2725Z02	○	25	27	25	35	90	125	8	4	2
08032E3432Z02	○	32	34	32	50	90	140	10	5	2
08040E4032Z03	○	40	40	32	60	90	150	18	6	3

Inserts are not included.

Inserts

Grade		Coated Carbide						P	Steel
Application	High Speed / Light Cutting	P	M	K	M	S		M	Stainless Steel
	General Purpose Cutting	P		K	M	S		K	Cast Iron
	Rough Cutting			K	M	S		S	Exotic Alloy
Cat. No.		ACP100	ACP200	ACP300	ACK200	ACK300	ACM200	ACM300	Radius
									RE
LNEX 080404 PNER-L		●	●	○	○	○	○	○	0,4
080408 PNER-L		●	●	○	○	○	○	○	0,8
080412 PNER-L		○	○	○	○	○	○	○	1,2
080416 PNER-L		○	○	○	○	○	○	○	1,6
LNEX 080404 PNER-G		○	●	●	●	●	●	●	0,4
080408 PNER-G		●	●	●	●	●	●	●	0,8
080412 PNER-G		○	●	●	●	●	●	●	1,2
080416 PNER-G		○	●	●	●	●	●	●	1,6

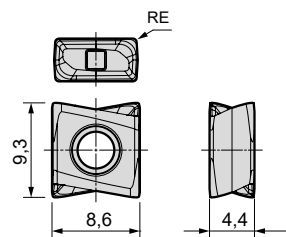

Recommended Cutting Conditions

Min. - Optimum - Max.

ISO	Work-material	Hardness	Cutting Speed v_c (m/min)	Feed Rate f_t (mm/T)	Grade
P	Carbon Steel	180-280HB	110-200-280	0,10-0,20-0,30	ACP100 ACP200 ACP300
		> 280HB	70-135-200	0,10-0,20-0,30	
	Alloy Steel	180-280HB	90-155-220	0,10-0,15-0,25	
M	Stainless Steel	220-280HB	90-135-180	0,10-0,15-0,25	ACM200 ACM300
		>280HB	70-115-160	0,10-0,15-0,25	
K	Cast Iron Ductile Cast Iron	250HB	125-175-225	0,10-0,20-0,30	ACK200 ACK300
S	Exotic Material	-	30-60-90	0,05-0,10-0,15	ACM200 ACM300

Identification Details

TSXR 08 025 E 27 25 Z02

Cutter Series	Insert Size	Cutter Diameter	Shank Type	Max. Depth of Cut	Shank Diameter	Effective Teeth
---------------	-------------	-----------------	------------	-------------------	----------------	-----------------

Spare Parts

Insert Wrench	Insert Screw
TRDR08IP	BFTX0308IP 2,0

"Sumi Dual Mill" Series TSXR 13000 E

Shank Type



Rake Angle	Radial	-23° - -18°	41-60 mm	90°
	Axial	-6° - -3°		

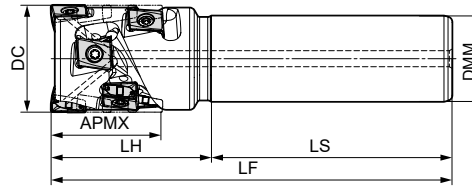

Body - TSXR

Cat. No.	Stock	Dimensions (mm)						No. of Teeth	Steps	Effective Teeth
		DC	APMX	DMM	LH	LS	LF			
TSXR 13040E4132Z02	○	40	41	32	60	90	150	8	4	2
13050E6042Z03	○	50	60	42	80	90	170	18	6	3

Inserts are not included.

Inserts

Application	Grade		Coated Carbide						P Steel		
	High Speed / Light Cutting		P	K	M	M	M	M	M	M	
	General Purpose Cutting		P	K	M	M	M	M	M	M	
Rough Cutting				K	M	M	M	M	S		
Cat. No.		ACP100	ACP200	ACP300	ACK200	ACK300	ACM200	ACM300	Radius		
										RE	
LNEX 130604 PNER-L		●	○	○	○	○	○	○	0,4		
130608 PNER-L		●	○	○	○	○	○	○	0,8		
130612 PNER-L		●	○	○	○	○	○	○	1,2		
130616 PNER-L		○	○	○	○	○	○	○	1,6		
130620 PNER-L		○	○	○	○	○	○	○	2,0		
130624 PNER-L		○	○	○	○	○	○	○	2,4		
130632 PNER-L		○	○	○	○	○	○	○	3,2		
LNEX 130604 PNER-G		○	●	●	●	●	○	○	0,4		
130608 PNER-G		○	●	●	●	●	○	○	0,8		
130612 PNER-G		○	●	●	●	●	○	○	1,2		
130616 PNER-G		○	●	●	●	●	○	○	1,6		
130620 PNER-G		○	○	○	○	○	○	○	2,0		
130624 PNER-G		○	○	○	○	○	○	○	2,4		
130632 PNER-G		○	○	○	○	○	○	○	3,2		
LNEX 130604 PNER-H		○	○	○	○	○	○	○	0,4		
130608 PNER-H		○	●	●	●	●	○	○	0,8		
130612 PNER-H		○	●	●	●	●	○	○	1,2		
130616 PNER-H		○	●	●	●	●	○	○	1,6		
130620 PNER-H		○	○	○	○	○	○	○	2,0		
130624 PNER-H		○	○	○	○	○	○	○	2,4		
130632 PNER-H		○	○	○	○	○	○	○	3,2		

Recommended Cutting Conditions

P14

Identification Details

TSXR 13 050 E 60 42 Z03

Cutter Series	Insert Size	Cutter Diameter	Shank Type	Max. Depth of Cut	Shank Diameter	Effective Teeth
TSXR	13	050	E	60	42	Z03

Spare Parts

Insert Wrench	Insert Screw
TRDR15IP	BFTX03510IP 3,0

"Sumi Dual Mill" Series TSXR

Order Sheet of TSX Repeater

Select a specialized shape and fill out the dimensions in the boxes.

Please contact us if you need different shapes, dimensions, etc.

Company name/contact information



Standard Specifications							
Applicable Inserts	Diameter (mm)	Max. Depth of Cut (mm)	Total Number of Teeth	Number of Stages	Max. Effective No. of Teeth	Specifications	
	DC	APMX				Shell Type	Shank Type
LNEX 08 (See P. 6)	20	21	3	3	1		O
	25	27	8	4	2		O
	32	34	10	5	2	O	O
	40	40	18	6	3	O	O
	50	54	32	8	4	O	
	63	60	45	9	5	O	
LNEX 13 (See P. 7)	40	41	8	4	2	O	O
	50	60	18	6	3	O	O
	63	60	24	6	4	O	
	80	60	30	6	5	O	
	100	60	36	6	6	O	
	125	60	42	6	7	O	

Shank Type Please refer to the standard specifications above when filling out.

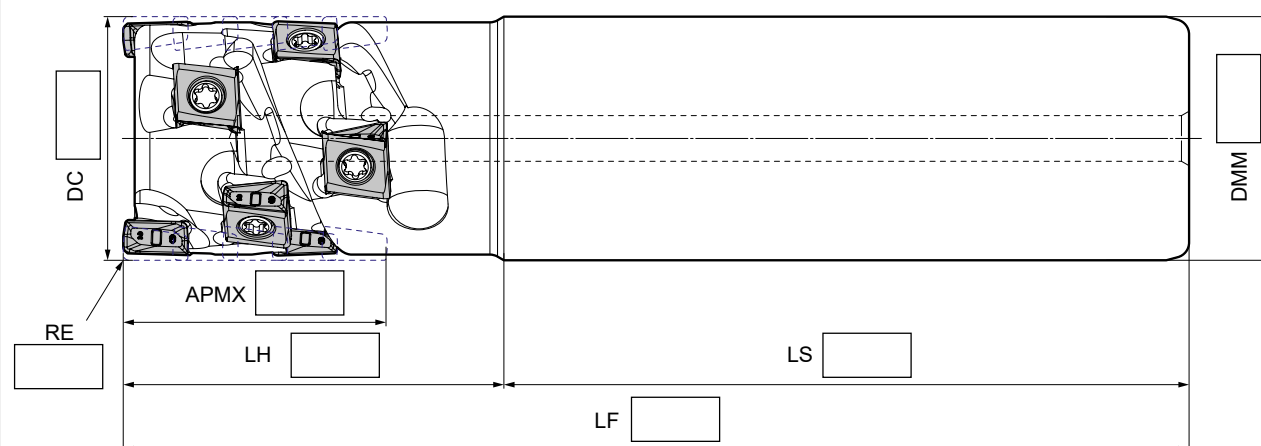

Included Parts

Wrench	Screw

Tip blade corner radius (RE) can be selected.

All other blades RE ≤ 0,8mm.

Required effective no. of teeth:

Coolant holes: Yes No

Order Sheet of TSX Repeater

Select a specialized shape and fill out the dimensions in the boxes.

Please contact us if you need different shapes, dimensions, etc.

Company name/contact information

Shell Type Please refer to the standard specifications when filling out. (see P. 16).

DC

RE

APMX

LF

CDBP

KDP

DCSFMS

KWW

DCB

Arbor Type Please refer to the standard specifications when filling out. (see P. 16).

DC



RE

APMX

LH

Interface

Included Parts

Wrench	Screw	Bolt
		
		*Shell type only

Tip blade corner radius (RE) can be selected.

All other blades RE ≤ 0,8mm.

Required effective no. of teeth:

Coolant holes: Yes No

"Sumi Dual Mill" Series TSX

Order Sheet of TSX Side Milling Cutter

Select a specialized shape and fill out the dimensions in the boxes.

Please contact us if you need different shapes, dimensions, etc.

Company name/contact information

Left-Handed Inserts

Cat. No.	Corner Radius (mm)						
	R0,4	R0,8	R1,2	R1,6	R2,0	R2,4	R3,2
LNEX 0804OOPNEL-L	<input type="checkbox"/>	<input type="checkbox"/>	<input type="checkbox"/>	<input type="checkbox"/>	-	-	-
LNEX 0804OOPNEL-G	<input type="checkbox"/>	<input type="checkbox"/>	<input type="checkbox"/>	<input type="checkbox"/>	-	-	-
LNEX 1306OOPNEL-L	<input type="checkbox"/>	<input type="checkbox"/>	<input type="checkbox"/>	<input type="checkbox"/>	<input type="checkbox"/>	<input type="checkbox"/>	<input type="checkbox"/>
LNEX 1306OOPNEL-G	<input type="checkbox"/>	<input type="checkbox"/>	<input type="checkbox"/>	<input type="checkbox"/>	<input type="checkbox"/>	<input type="checkbox"/>	<input type="checkbox"/>

Delivery on request - not available



Specialized Insert Support:

LNEX 08 corner radius (RE) = 0,4 to 1,6 mm, support for left and right handed operation
LNEX 13 corner radius (RE) = 0,4 to 3,2 mm, support for left and right handed operation.

CW Size Standard Specifications	
14 mm	LNEX 08 (see P. 6)
18 – 22 mm	LNEX 13 (see P. 7)

*CW sizes above those stated here use a multi-stage design.

Included Parts

Wrench	Screw
	

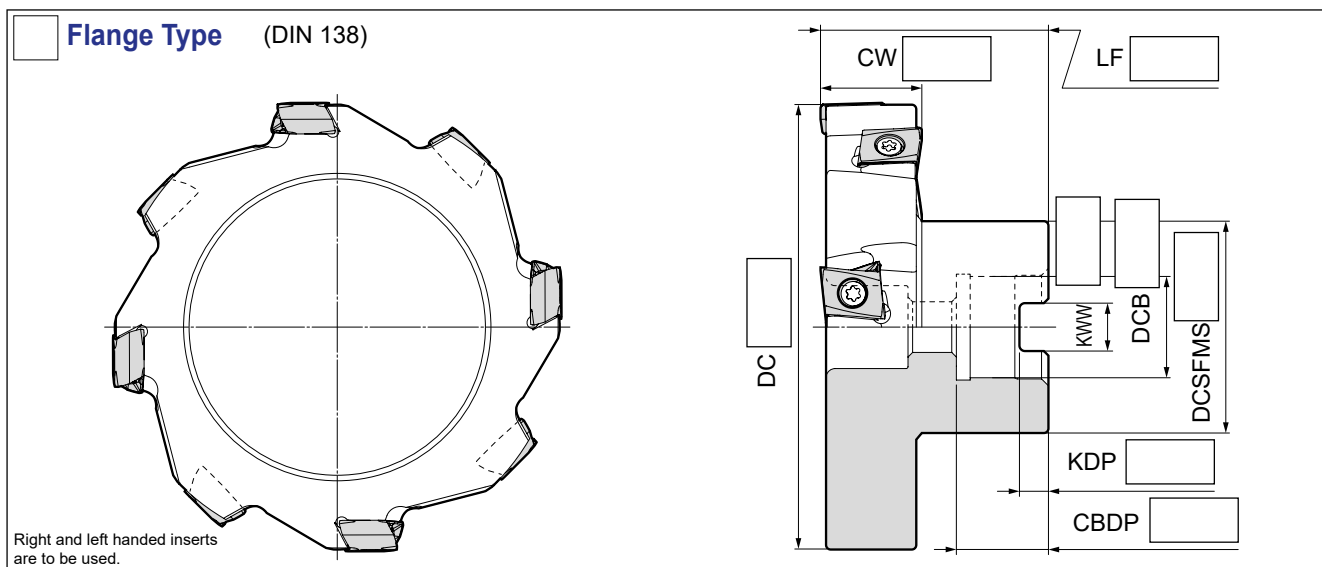
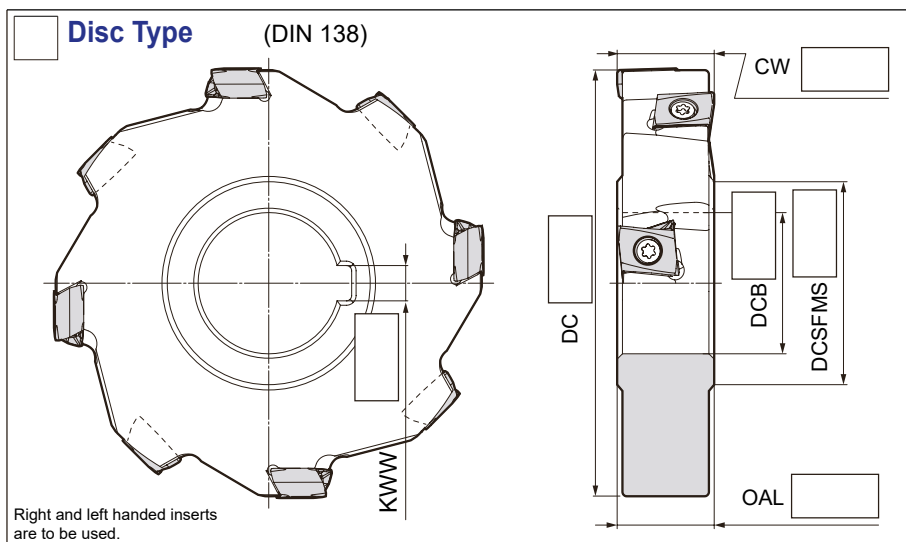

Please fill in required effective no. of teeth

"Sumi Dual Mill" Series TSX Special Type

Order Sheet of TSX Specialized Design

Select a specialized shape and fill out the dimensions in the boxes.

Please contact us if you need different shapes, dimensions, etc.

Company name/contact information

Left-Handed Inserts

Cat. No.	Corner Radius (mm)						
	R0,4	R0,8	R1,2	R1,6	R2,0	R2,4	R3,2
LNEX 0804OOPNEL-L	<input type="checkbox"/>	<input type="checkbox"/>	<input type="checkbox"/>	<input type="checkbox"/>	-	-	-
LNEX 0804OOPNEL-G	<input type="checkbox"/>	<input type="checkbox"/>	<input type="checkbox"/>	<input type="checkbox"/>	-	-	-
LNEX 1306OOPNEL-L	<input type="checkbox"/>	<input type="checkbox"/>	<input type="checkbox"/>	<input type="checkbox"/>	<input type="checkbox"/>	<input type="checkbox"/>	<input type="checkbox"/>
LNEX 1306OOPNEL-G	<input type="checkbox"/>	<input type="checkbox"/>	<input type="checkbox"/>	<input type="checkbox"/>	<input type="checkbox"/>	<input type="checkbox"/>	<input type="checkbox"/>

Delivery on request - not available



Specialized Insert Support:

LNEX 08 corner radius (RE) = 0,4 to 1,6 mm, support for left and right handed operation
LNEX 13 corner radius (RE) = 0,4 to 3,2 mm, support for left and right handed operation

CW Size Standard Specifications	
14 mm	LNEX 08 (see P. 6)
18 – 22 mm	LNEX 13 (see P. 7)

*CW sizes above those stated here use a multi-stage design.

Included Parts

Wrench	Screw
	

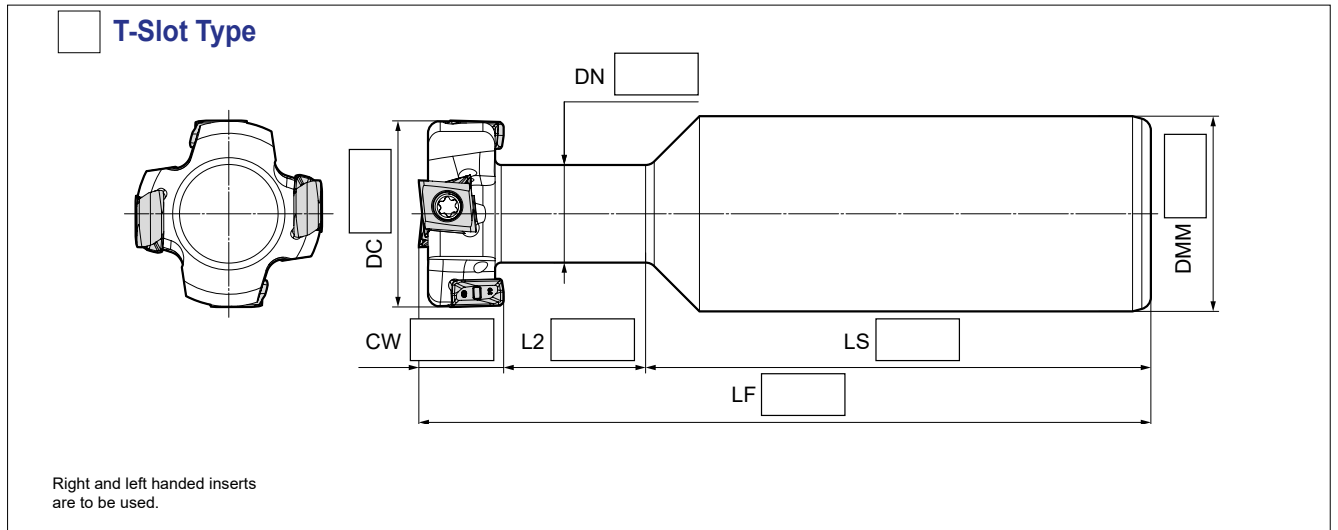

Required effective no. of teeth

Coolant holes: Yes No

Other TSX Special Types:

TSX Face Milling Cutter 45° (60°)



Maximum efficiency in face milling while roughing of steel and cast iron materials.

TSX High Feed Cutter



High feed rate with very good surface finishes.

TSX Plunge Milling Cutter





Very well suited for roughing operations with longer overhang. Optimal for machining with lower drive power.

"Sumi Dual Mill" Series TSX

Application Examples

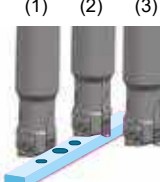
Workpiece		Sumitomo	Competitor
 <p>Ring</p>	Material: 25CrMo4		
	Tool	TSXM 13080RS	-
	Grade	ACP200	-
	Chipbreaker	H	-
	Tool Diam. (mm)	80	80
	No. of Teeth	7	6
	v_c (m/min)	180	180
	v_f (mm/min)	950	950
	f_z (mm/t)	0,2	0,2
	a_p (mm)	3,8	3,8
	a_e (mm)	50,0	50,0
	Coolant	Dry	Dry
	Result	Achieving 3,3 x longer tool life.	

Workpiece		Sumitomo	Conventional
 <p>(1) (2) (3)</p> <p>(1) (2) Side face milling (3) Face milling</p> <p>Mechanical parts</p>	Material: 42CrMo4		
	Tool	TSXF 08020E	Vertical 4 corner
	Grade	ACP200	-
	Chipbreaker	G	-
	Tool Diam. (mm)	20	20
	No. of Teeth	3	3
	v_c (m/min)	270	270
	v_f (mm/min)	650	650
	f_z (mm/t)	0,05	0,05
	a_p (mm)	8,0	8,0
	a_e (mm)	0,64	0,64
	Coolant	Wet	Wet
	Result	Faster finish compared to conventional products due to superior shoulder squareness.	

Workpiece		Sumitomo	Conventional
 <p>Housing</p>	Material: GGG		
	Tool	TSXM 13050RS	One-size 4 corner
	Grade	ACK300	-
	Chipbreaker	G	-
	Tool Diam. (mm)	50	50
	No. of Teeth	5	5
	v_c (m/min)	240	240
	v_f (mm/min)	1150	1150
	f_z (mm/t)	0,13	0,13
	a_p (mm)	1,0	1,0
	a_e (mm)	30,0	30,0
	Coolant	Dry	Dry
	Result	Achieving 30% longer tool life.	

Workpiece		Sumitomo	Conventional
 <p>Cylinder block</p>	Material: GG-25		
	Tool	TSX 13050RS	-
	Grade	ACK300	-
	Chipbreaker	L	-
	Tool Diam. (mm)	50	50
	No. of Teeth	4	4
	v_c (m/min)	235	235
	v_f (mm/min)	600	600
	f_z (mm/t)	0,1	0,1
	a_p (mm)	0,8	0,8
	a_e (mm)	0,8	0,8
	Coolant	Wet	Wet
	Result	Superior dimensional accuracy and surface finish compared to conventional products.	



CARBIDE - CBN - DIAMOND

(Germany)
SUMITOMO ELECTRIC Hartmetall GmbH
Konrad-Zuse-Straße 9, 47877 Willich

Tel. +49 2154 4992-0, Fax +49 2154 4992-161
Info@SumitomoTool.com
www.SumitomoTool.com



(UK and Ireland)
SUMITOMO ELECTRIC Hardmetal Ltd.
Summerleys Road, Princes Risborough
Buckinghamshire HP27 9PW, UK

Tel. +44 1844 342081, Fax: +44 1844 342415
InfoUK@SumitomoTool.com
www.SumitomoTool.com



Distributed by: