

High-efficiency and High-rigidity  
Radius Milling Cutter

SEC-Wave Radius Mill **RSE** Series

**Tough cutter for high-efficiency  
machining of stainless steel and  
exotic alloy**



Lineup of Ground Type and M Class Inserts



### ■ Features

- High-efficiency, high-rigidity radius cutter  
Wide insert seat face design achieves excellent durability, for high efficiency machining of stainless steel etc. and is ideal for roughing of aerospace components such as turbine blades.
- Lineup of ground type and M class inserts  
In addition to the 4-cornered Ground type inserts, economical 8-cornered M Class inserts are also available.
- Uses new grades for exotic alloy machining  
Utilizing newly developed ACS2500/ACS3000 grades to achieve stable and long tool life in machining exotic alloys, such as titanium alloys and Ni-based heat-resistant alloys, as well as stainless steel.

### ■ High-rigidity clamp design

### Wide Insert Seat Face Design

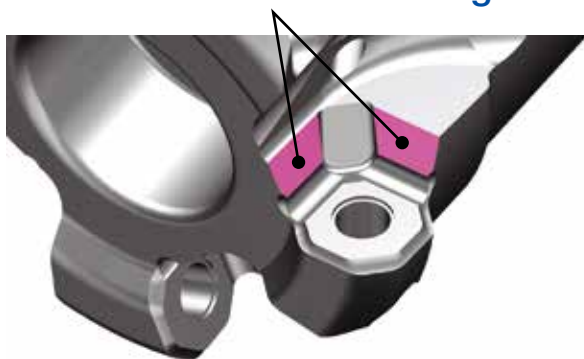

### ■ Cutter body can be shared by optimizing the locating surface design

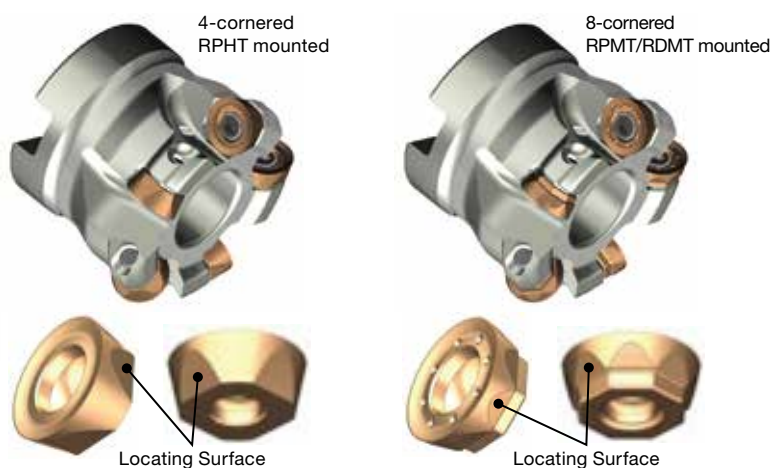



4-cornered Ground type inserts and 8-cornered M Class inserts can be used on the same cutter body

### ■ Product Range

Type	Cat. No.	Max. Diameter (mm)							
		ø25	ø32	ø40	ø42	ø50	ø52	ø63	ø80
Shell	RSE 10000RS○○			5		6			
	RSE 12000RS○○			4	4	5 6	5	6	8
	RSE 12000R○○ <small>Inch</small>								8
Shank	RSE 10000E○○	2 3	3 4						





Number in ● shows the number of teeth Inch Inch Bore

**Grade Features**

Work Material	Grade	Coating Thickness (μm)	Features
 ACS2500	ACS2500	3	Carbide substrate with excellent wear and adhesion resistance, coupled with a chipping resistant coating, provide outstanding performance especially in machining <b>titanium alloys</b>
 ACS3000	ACS3000	3	High toughness carbide substrate and coating with excellent chipping resistance provide outstanding stability when machining <b>titanium alloys, heat-resistant alloys or stainless steel</b>

**Grade Application Range**

The newly developed **ACS2500/ACS3000** grades ideal for machining titanium alloys, heat-resistant alloys and stainless steel are now available!

Work Material	Coated Carbide	Finishing to Light Cutting	Medium Cutting	Rough to Heavy Cutting
 ACS2500		ACS2500		
 ACS3000			ACS3000	

The letters "C" and "P" at the end of each grade indicate the coating type. ▽: CVD ▲: PVD

**Cutting Performance**

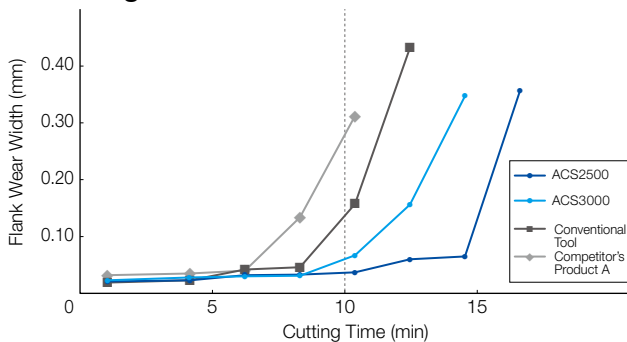

Machine : Vertical Machining Centre BT40, Work Material: SUS630H  
 Tool : RSE 12050RS05, Insert: RPHT1204M0EN-G  
 Cutting conditions :  $v_c = 150\text{m/min}$   $f_z = 0.3\text{mm/t}$   $a_p = 2\text{mm}$   $a_e = 10\text{mm}$  Wet

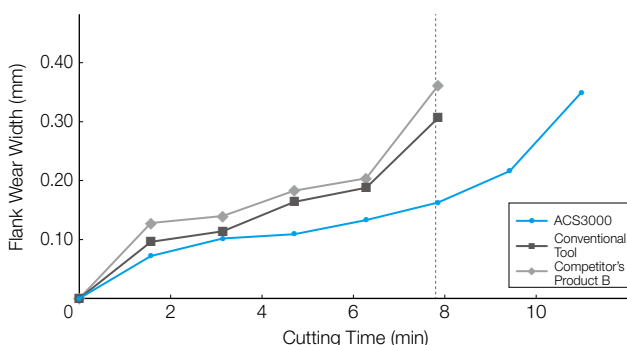

Machine : Vertical Machining Centre BT40, Work Material: Inconel 718 (44HRC)  
 Tool : RSE 12050RS05, Insert: RPHT1204M0EN-G  
 Cutting conditions :  $v_c = 40\text{m/min}$   $f_z = 0.3\text{mm/t}$   $a_p = 2\text{mm}$   $a_e = 30\text{mm}$  Wet



**New PVD Coating Features**

**ABSOTECH**
**PVD**

**Ultra-fine grained B additive**  
 · New AlTiBN coating, with an ultra-fine coating structure, achieves high strength and toughness  
 · Outstanding chipping resistance and wear resistance

**High Adhesion Strength**  
 Significantly improved coating adhesion and more than 2x conventional chipping resistance

**Chipbreaker Shape**

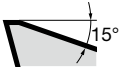
Work Material	 Stainless Steel,  Exotic Alloy
Applications	General-purpose to roughing
Features	Standard
Chipbreaker	<b>G Type</b> 
Cutting Edge Cross Section	



**Superb wear resistance for a tool life 1.4 times greater than that of conventional tools and competitor's products**



**Superb fracture resistance for a tool life 1.4 times greater than that of conventional tools and competitor's products**

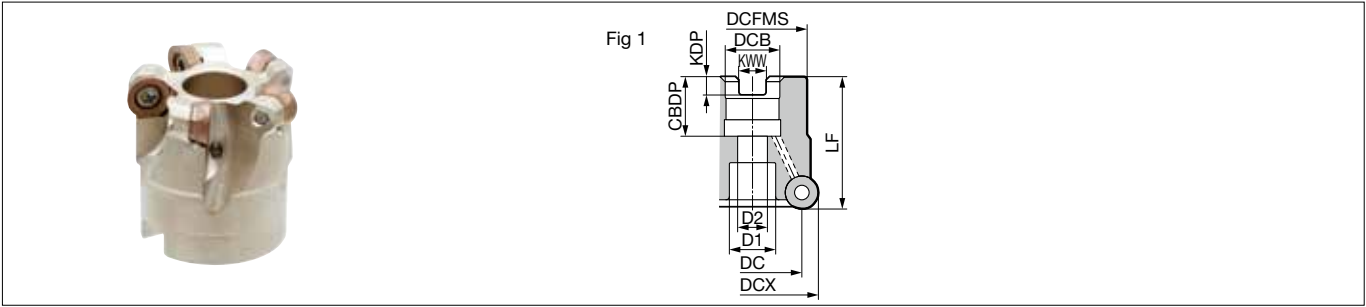
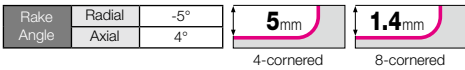

### ■ Body (Shell Type)

Dimensions (mm)

	Cat. No.	Stock	Max. Dia. DCX	Dia. DC	Boss DCSFMS	Height LF	Hole Dia. DCB	Keyway Width KWW	Keyway Depth KDP	Mounting Depth CDBP	Bolt D1	Bolt D2	Number of Teeth	Weight (kg)	Fig
Metric	<b>RSE 10040RS05</b>	○	<b>40</b>	30	33	40	<b>16</b>	8.4	5.6	18	14	9	5	0.16	1
	<b>10050RS06</b>	○	<b>50</b>	40	40	40	<b>22</b>	10.4	6.3	20	18	11	6	0.27	1

Inserts are sold separately.

### ■ Identification Code

## RSE 10 040 R S 05

Series    Insert Size    Dia.    Feed Direction    Metric Bore    Number of Teeth

### ■ Parts

Flat Insert Screw	Detachable Wrench		Anti-seizure Cream
	Handle Grip	Bit	
BFTX03584IP <b>3.0</b>	HPS1015	TRB15IP	SUMI-P

## ■ Insert

Dimensions (mm)

Grade Classification		Coated Carbide		Inscribed Circle IC	Thickness S	Fig
Process	High-speed/Light					
	Medium Cutting					
	Roughing					
Cat. No.		ACS2500	ACS3000			
<b>RPHT10T3M0EN-G</b>		○	○	10	3.97	1
<b>RPMT10T3M0EN-G</b>		○	○	10	3.97	2
<b>RDMT10T3M0EN-G</b>		○	○	10	3.97	3

Fig 1 4-cornered

Fig 2 8-cornered

Fig 3 8-cornered

## ■ Recommended Cutting Conditions

ISO	Work Material		Hardness	Chipbreaker	Cutting Speed $v_c$ (m/min) Min. - <b>Optimum</b> - Max.	Feed Rate $f_z$ (mm/t) Min. - <b>Optimum</b> - Max.	Grade
<b>S</b>	Exotic Alloy	Heat-Resistant Alloy	—	G	25 - <b>35</b> - 50	0.15 - <b>0.25</b> - 0.35	ACS2500/ACS3000
		Ti Alloy	—	G	30 - <b>60</b> - 90	0.15 - <b>0.25</b> - 0.35	ACS2500/ACS3000
<b>M</b>	Stainless Steel	SUS430 and Others (Martensitic/Ferritic)	200HB	G	115 - <b>145</b> - 175	0.15 - <b>0.30</b> - 0.45	ACS2500/ACS3000
		SUS403 and Others (Martensitic/Hardened)	240HB	G	105 - <b>130</b> - 155	0.15 - <b>0.30</b> - 0.45	ACS2500/ACS3000
		SUS304, SUS316 (Austenitic)	180HB	G	125 - <b>155</b> - 190	0.15 - <b>0.30</b> - 0.45	ACS2500/ACS3000

**Note** · The recommended cutting conditions may not be practical depending on the operating conditions (e.g. machine, work material shape, clamping system).  
 · For groove milling, calculate the feed rate at around 70% of the above values.  
 · The cutting conditions above are a guide. Actual conditions will need to be adjusted according to machine rigidity, work clamp rigidity, depth of cut and other factors.

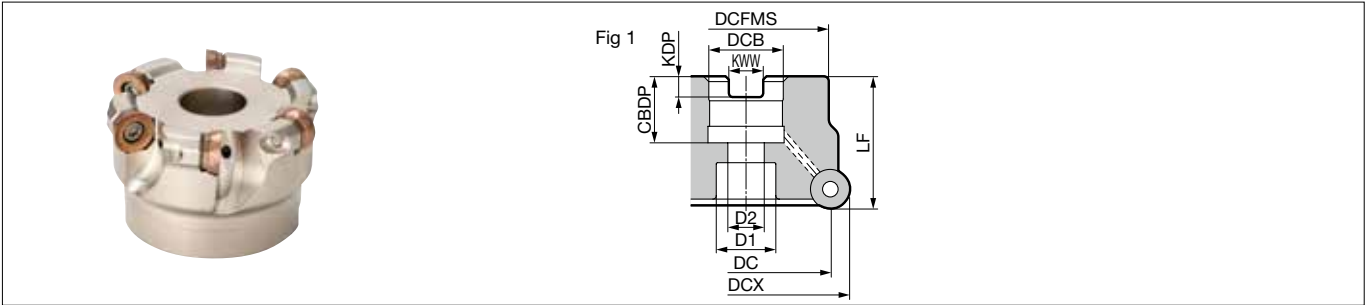
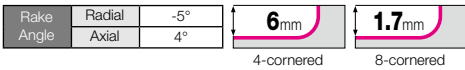

## ■ Body (Shell Type)

Dimensions (mm)

Cat. No.		Stock	Max. Dia. DCX	Dia. DC	Boss DCSFMS	Height LF	Hole Dia. DCB	Keyway Width KWW	Keyway Depth KDP	Mounting Depth CDBP	Bolt D1	Bolt D2	Number of Teeth	Weight (kg)	Fig
Metric	<b>RSE 12040RS04</b>	○	40	28	33	40	16	8.4	5.6	18	13.5	9	4	0.15	1
	<b>12042RS04</b>	○	42	30	33	40	16	8.4	5.6	18	14	9	4	0.17	1
	<b>12050RS05</b>	○	50	38	41	40	22	10.4	6.3	20	18	11	5	0.24	1
	<b>12050RS06</b>	○	50	38	41	40	22	10.4	6.3	20	18	11	6	0.23	1
	<b>12052RS05</b>	○	52	40	41	40	22	10.4	6.3	20	18	11	5	0.26	1
	<b>12063RS06</b>	○	63	51	50	40	22	10.4	6.3	20	18	11	6	0.47	1
	<b>12080RS08</b>	○	*80	68	55	50	27	12.4	7	22	20	14	8	0.89	1
Inch	<b>12080R08</b>	○	*80	68	55	50	25.4	12.4	7	22	20	14	8	0.90	1

Inserts are sold separately.

For mounting the ø80mm sized cutters marked with \* to an arbor, use a JIS B1176 hexagonal socket bolt (M12 x 30 to 35mm).

## ■ Identification Code

# RSE 12 050 R S 05

Series    Insert Size    Dia.    Feed Direction    Metric Bore    Number of Teeth

## ■ Parts

Flat Insert Screw		Detachable Wrench		Anti-seizure Cream
		Handle Grip	Bit	
BFTX040951P	3.0	HPS1015	TRB151P	SUMI-P

## ■ Insert

Dimensions (mm)

Grade Classification		Coated Carbide		Inscribed Circle IC	Thickness S	Fig
Process	High-speed/Light					
	Medium Cutting					
	Roughing					
Cat. No.		ACS2500	ACS3000			
<b>RPHT1204M0EN-G</b>		○	○	12	4.76	1
<b>RPMT1204M0EN-G</b>		○	○	12	4.76	2
<b>RDMT1204M0EN-G</b>		○	○	12	4.76	3

Fig 1 4-cornered

Fig 2 8-cornered

Fig 3 8-cornered

## ■ Recommended Cutting Conditions

ISO	Work Material		Hardness	Chipbreaker	Cutting Speed $v_c$ (m/min) Min. - <b>Optimum</b> - Max.	Feed Rate $f_z$ (mm/t) Min. - <b>Optimum</b> - Max.	Grade
<b>S</b>	Exotic Alloy	Heat-Resistant Alloy	—	G	25 - <b>35</b> - 50	0.15 - <b>0.25</b> - 0.35	ACS2500/ACS3000
		Ti Alloy	—	G	30 - <b>60</b> - 90	0.15 - <b>0.25</b> - 0.35	ACS2500/ACS3000
<b>M</b>	Stainless Steel	SUS430 and Others (Martensitic/Ferritic)	200HB	G	115 - <b>145</b> - 175	0.15 - <b>0.30</b> - 0.45	ACS2500/ACS3000
		SUS403 and Others (Martensitic/Hardened)	240HB	G	105 - <b>130</b> - 155	0.15 - <b>0.30</b> - 0.45	ACS2500/ACS3000
		SUS304, SUS316 (Austenitic)	180HB	G	125 - <b>155</b> - 190	0.15 - <b>0.30</b> - 0.45	ACS2500/ACS3000

**Note** · The recommended cutting conditions may not be practical depending on the operating conditions (e.g. machine, work material shape, clamping system).  
 · For groove milling, calculate the feed rate at around 70% of the above values.  
 · The cutting conditions above are a guide. Actual conditions will need to be adjusted according to machine rigidity, work clamp rigidity, depth of cut and other factors.

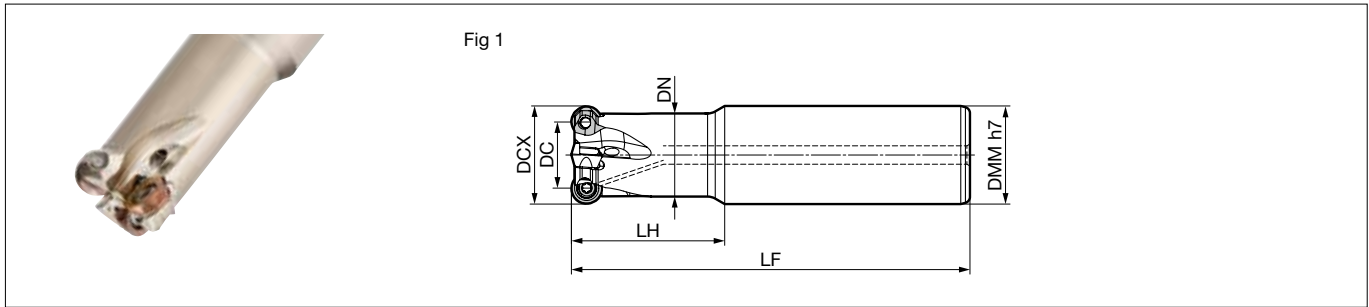
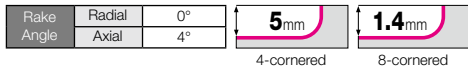

### ■ Body (Shank Type)

Dimensions (mm)

Cat. No.	Stock	Max. Dia. DCX	Dia. DC	Shank DMM	Diameter DN	Head LH	Overall Length LF	Number of Teeth	Weight (kg)	Fig
<b>RSE 10025E02</b>	○	25	15	25	20.3	50	130	2	0.40	1
<b>10025E03</b>	○	25	15	25	20.3	50	130	3	0.39	1
<b>10032E03</b>	○	32	22	32	27.1	50	130	3	0.68	1
<b>10032E04</b>	○	32	22	32	27.1	50	130	4	0.67	1

Inserts are sold separately.

### ■ Identification Code

## RSE 10 032 E 03

Series
Insert Size
Dia.
Shank Type
Number of Teeth

### ■ Parts

Flat Insert Screw	Wrench	Anti-seizure Cream
BFTX03584IP	3.0 TRDR15IP	SUMI-P



## ■ Insert

Dimensions (mm)

Grade Classification		Coated Carbide		Inscribed Circle IC	Thickness S	Fig
Process	High-speed/Light					
	Medium Cutting					
	Roughing					
Cat. No.		ACS2500	ACS3000			
<b>RPHT10T3M0EN-G</b>		○	○	10	3.97	1
<b>RPMT10T3M0EN-G</b>		○	○	10	3.97	2
<b>RDMT10T3M0EN-G</b>		○	○	10	3.97	3

Fig 1 4-cornered

Fig 2 8-cornered

Fig 3 8-cornered

## ■ Recommended Cutting Conditions

ISO	Work Material		Hardness	Chipbreaker	Cutting Speed $v_c$ (m/min) Min. - <b>Optimum</b> - Max.	Feed Rate $f_z$ (mm/t) Min. - <b>Optimum</b> - Max.	Grade
<b>S</b>	Exotic Alloy	Heat-Resistant Alloy	—	G	25 - <b>35</b> - 50	0.15 - <b>0.25</b> - 0.35	ACS2500/ACS3000
		Ti Alloy	—	G	30 - <b>60</b> - 90	0.15 - <b>0.25</b> - 0.35	ACS2500/ACS3000
<b>M</b>	Stainless Steel	SUS430 and Others (Martensitic/Ferritic)	200HB	G	115 - <b>145</b> - 175	0.15 - <b>0.30</b> - 0.45	ACS2500/ACS3000
		SUS403 and Others (Martensitic/Hardened)	240HB	G	105 - <b>130</b> - 155	0.15 - <b>0.30</b> - 0.45	ACS2500/ACS3000
		SUS304, SUS316 (Austenitic)	180HB	G	125 - <b>155</b> - 190	0.15 - <b>0.30</b> - 0.45	ACS2500/ACS3000

**Note** · The recommended cutting conditions may not be practical depending on the operating conditions (e.g. machine, work material shape, clamping system).  
 · For groove milling, calculate the feed rate at around 70% of the above values.  
 · The cutting conditions above are a guide. Actual conditions will need to be adjusted according to machine rigidity, work clamp rigidity, depth of cut and other factors.

# MEMO

A large grid of dotted lines for writing a memo. The grid consists of 20 columns and 30 rows of small squares, providing a structured space for text entry.

# MEMO

A large grid of dotted lines for writing a memo. The grid consists of 20 columns and 30 rows of small squares, providing a structured space for text entry.



(Germany)  
SUMITOMO ELECTRIC Hartmetall GmbH  
Konrad-Zuse-Straße 9, 47877 Willich

Tel. +49 2154 4992-0, Fax +49 2154 4992-161  
Info@SumitomoTool.com  
www.SumitomoTool.com



(UK and Ireland)  
SUMITOMO ELECTRIC Hardmetal Ltd.  
3 Paper Mill Drive  
Redditch, B98 8QJ, UK

Tel. +44 1844 342081, Fax: +44 1844 342415  
InfoUK@SumitomoTool.com  
www.SumitomoTool.com



Distributed by: