

# High Feed Turning (HFT-O / HFT-D) with CBN

HFT System with Octagon & Rhomboid Shape CBN Inserts



## Advantages:

- Up to 8 times higher productivity than conventional hard turning
- Octagon CBN insert (8 cutting edges) and rhomboid shape CBN insert (2 cutting edges)
- Special wiper technology with smooth cutting edge entry on the workpiece
- Good surface roughness ( $R_z < 4 \mu\text{m}$ ) even at elevated feed rates of  $f = 1,2 \text{ mm/rev}$
- Stable monoblock design holders based on HSK, ISO-PSC, VDI, KM or DIN coupling
- High cutting removal rates while maintaining required qualities
- Special tools on request available



# For Hardened Steel High Feed Turning (HFT-O)

## ■ Monoblock Tool Holders in Various Design

Combination possible to adopt to different applications like boring, facing, outer diameter turning, chamfering.  
Couplings available as VDI, ISO-PSC, DIN, KM and HSK shank.

### VDI



### ISO-PSC



### DIN



### KM



High stability double clamp system

Direction defined coolant / air supply

ONXA octagon CBN insert

Easy handling and secure insert guiding in stable insert seat

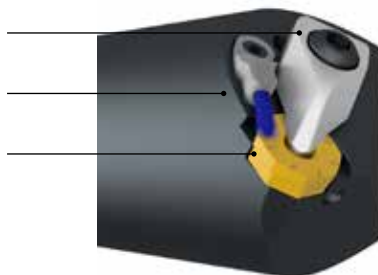

## ■ Cutting Conditions

General Conditions*	$v_c = 80-200$ m/min	$f = 0,2-1,2$ mm/rev	$a_p = 0,05-0,25$ mm
---------------------	----------------------	----------------------	----------------------

\* are set according to the project

## ■ CBN Choice

Grade	BNC200	BNC30G
Typ of cut	Continuous cut	Interrupted cut

## ■ HFT-O Offering Production Cost Reduction

Cutting process time was reduced **90 %**

### Productivity roughing

**HFT-O**  
 $v_c = 150$  m/min  
 $f = 1,2$  mm/rev  
 $a_p = 0,12$  mm

**Standard**  
 $v_c = 100$  m/min  
 $f = 0,18$  mm/rev  
 $a_p = 0,10$  mm

Increased productivity

12 times

### Productivity finishing

**HFT-O**  
 $v_c = 150$  m/min  
 $f = 0,8$  mm/rev  
 $a_p = 0,03$  mm

**Standard**  
 $v_c = 120$  m/min  
 $f = 0,14$  mm/rev  
 $a_p = 0,05$  mm

Increased productivity

16 times

Result: **HFT-O** = 12–16 times faster than existing process with keeping the requested tolerances and surface roughness requirements.  
Insert offers double number of cutting edges. Additionally, the tool life could be doubled.

## ■ General Details

To machine close to shoulder (inner or outer diameter) you need a relief groove of approximately 8 mm.

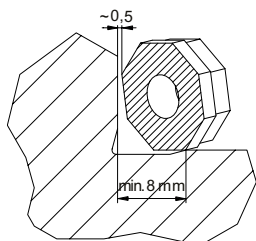

Distance overhang shaft exit 1 mm      Safety distance shaft entrance 1 mm

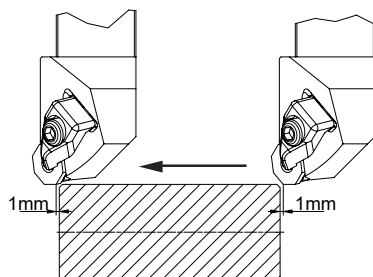

Safety distance hole entrance 1 mm      Distance overhang hole exit 1 mm

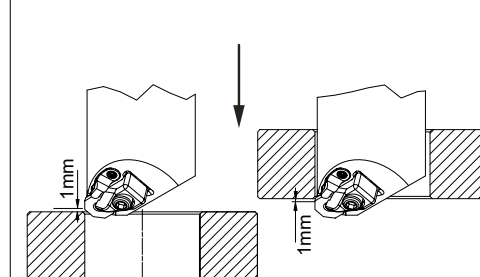

# For Hardened Steel High Feed Turning (HFT-D)

## Monoblock Tool Holders in Various Design

Combination possible to adopt to different applications like boring, facing, outer diameter turning, chamfering.  
Couplings available as VDI, ISO-PSC, DIN, KM and HSK shank.

### VDI



### ISO-PSC



### DIN

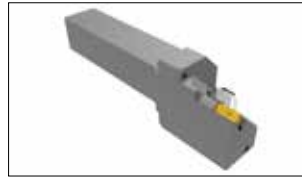

### KM



Easy handling and secure insert guiding  
in stable insert seat

Direction defined coolant / air supply

DNXA rhombic shape CBN insert

High stability double clamp system

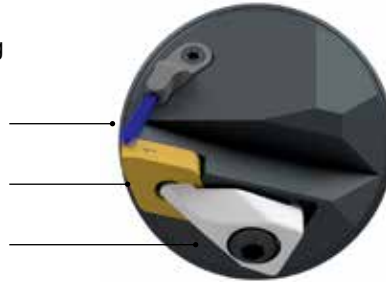

## Cutting Conditions

General Conditions*	$v_c = 80\text{--}200$ m/min	$f = 0,1\text{--}1,2$ mm/rev	$a_p = 0,03\text{--}0,45$ mm
---------------------	------------------------------	------------------------------	------------------------------

\* are set according to the project

## CBN Choice

Grade	BNC200	BNC30G
Typ of cut	Continuous cut	Interrupted cut

## HFT-D Offering Production Cost Reduction

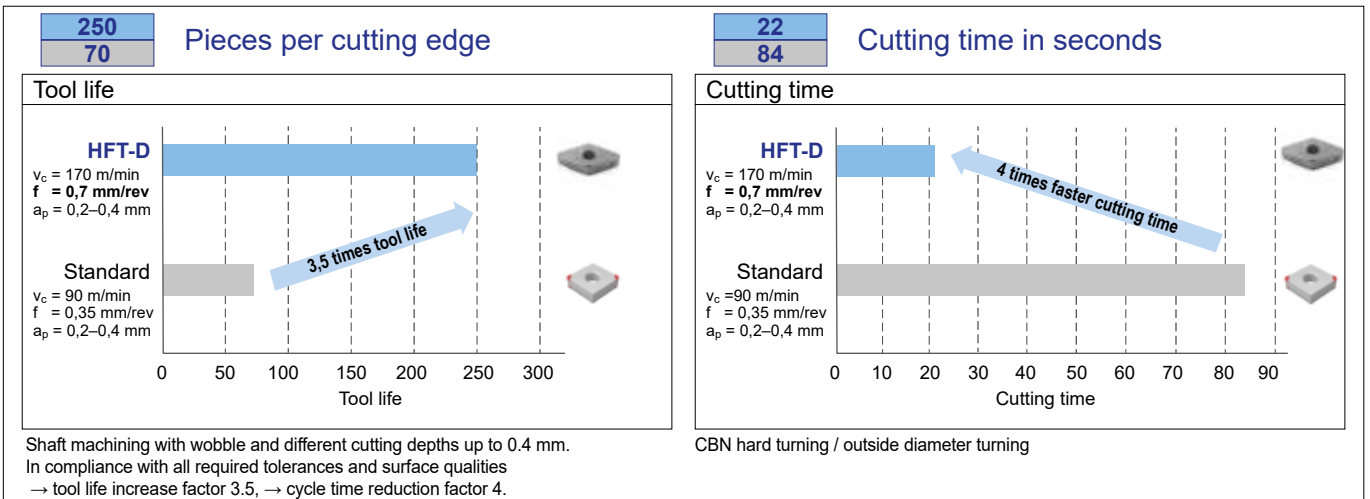

## General Details

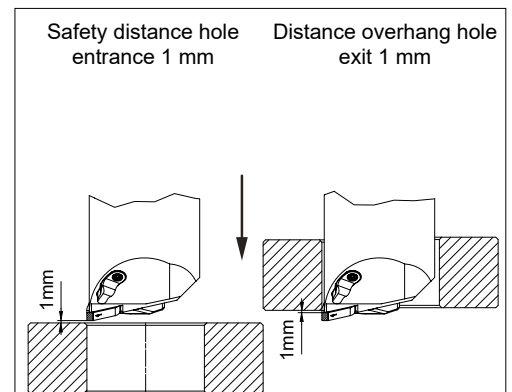
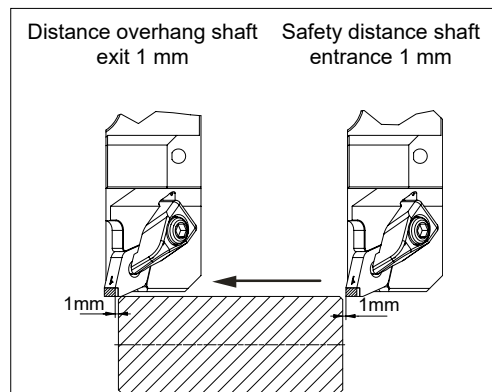
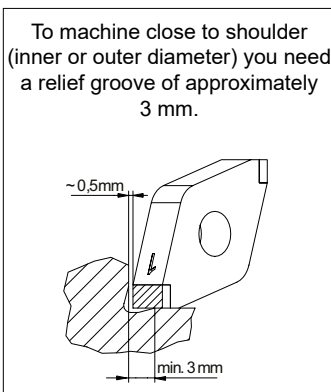

# For Hardened Steel High Feed Turning

## ■ Application Range

### Inner Diameter Turning

- Through hole application is recommended (blind hole makes chip stacking and jamming).
- Inner diameter has to be more than 50 mm.
- Additional interfaces can be adapted to increase the turning length.
- Length of cut is recommended less than 3xD.

### Outer Diameter Turning and Facing

- Straight outer diameter turning and facing.
- No limitation of work size, but rigidity of the workpiece and clamping is important.
- Additional interfaces can be adapted to increase the turning length.

### Taper, Sheave Surface Turning

- Different approach angles of the insert can be introduced into the system according to the customer's requirements.

### Inner Diameter Turning

Ring Gear , HFT-D, BNC200



Face Gear, HFT-O, BNC30G



Pipe, HFT-D, BNC30G

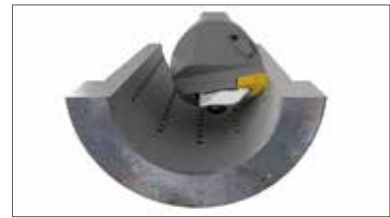

### Inside Turning, Outside Turning

Bearing Ring, HFT-D/HFT-O, BNC200, BNC30G



### Inside Turning, Front Facing and Rear Side

Shift Wheel, HFT-D & ISO, BNC200

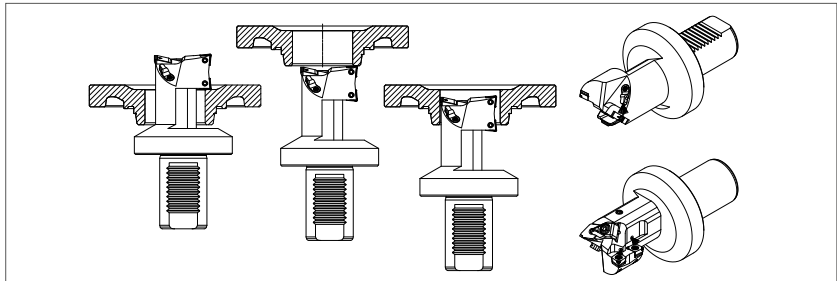

### Outer Diameter Turning and Facing

Drive Shaft, HFT-D, BNC200



Drive Shaft, HFT-O, BNC30G



Protection Disc, HFT-D/HFT-O, BNC200



### Taper, Sheave and Surface Turning

Taper Roller, HFT-D, BNC200, BNC30G



Taper Roller, HFT-D, BNC200, BNC30G



Bearing Ring, HFT-D/HFT-O, BNC200, BNC30G



# For Hardened Steel High Feed Turning (HFT-O)

## HFT DOXN R/L 2525M 1204

Outer Diameter Turning, Facing, Boring possible

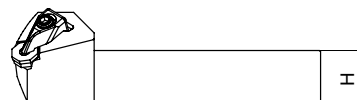
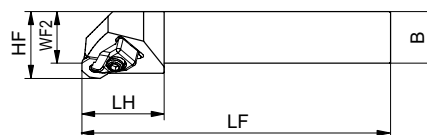
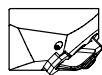
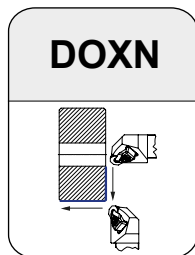

Above figures show right hand tools.

Attention: You need approximately 8 mm overhang on the shoulder (see page 2)

### ■ Holders

Cat. No.	Stock		Dimensions (mm)					
	R	L	H	B	LF	WF2	HF	LH
HFT DOXN R/L 2525M 1204	●	●	25	25	150	25	32,5	40

### ■ Spare Parts for Clamping System

Clamp	Spring	Clamp Bolt	Clamp Wrench	Shim	Screw	Screw Wrench
SCP2 (Set)	5	5 (N-m)	LH040	CSCFHFT	MIB1.6-3	SDBSM

### ■ CBN-Inserts

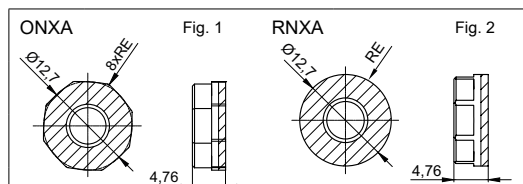

E00200: Cutting edge rounded 10–20 µm, B: Full top CBN insert

Cat. No.	Grade		RE (mm)	Outer Diam. Turning	Facing	Boring possible	Applicable Holder	Fig.
	BNC30G	BNC200						
ONXA 1204 R150 R E00200 B*	●	●	150	⊙	—	—	HFT DOXN R 2525M 1204	1
ONXA 1204 R150 L E00200 B**	●	●	150	⊙	—	—	HFT DOXN L 2525M 1204	1
ONXA 1204 R28 R E00200 B*	●	●	28	○	⊙	⊙	HFT DOXN R 2525M 1204	1
ONXA 1204 R28 L E00200 B**	●	●	28	○	⊙	⊙	HFT DOXN L 2525M 1204	1
RNXA 1204 N E00200 B***	●	●	6,35	○	○	○	HFT DOXN R/L 2525M 1204	2

\* Right handed (R) octagon inserts can only be used in right handed (R) tools.

\*\* Left handed (L) octagon inserts can only be used in left handed (L) tools.

\*\*\* Can be used in right (R) or left (L) handed tool holders. Round inserts produce less cutting pressure when turning compared to octagonal inserts, but the quality of surface finish is also reduced.

⊙ Preferred choice

○ Suitable

— Not possible

### ■ Identification Details - Holder

HFT	DOXN	R/L	25	25	M	1204
Holder Description „High Feed Turning“	Clamping System D: Double Clamp O: Insert Shape X: Holder Style N: Relief Angle=0°	Feed Direction R: Right Hand L: Left Hand	Shank Height (H)	Shank Width (B)	Holder Length	Insert Size

● = Euro stock

# For Hardened Steel High Feed Turning (HFT-D)

## HFT DDXN R/L 2525M 1504

Outer Diameter Turning, Facing

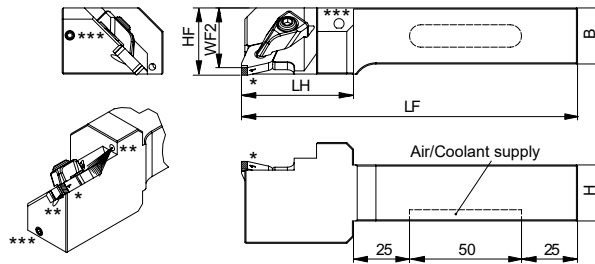
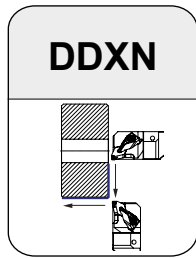

\* Note mounting position: Cutting edge number must be visible as shown.

\*\* Air / coolant outlet

\*\*\* Screw plugs for air / coolant transfer shall not be removed.

Above figures show right hand tools.

Attention: You need approximately 3 mm overhang on the shoulder (see page 3)

### ■ Holders

Cat. No.	Stock		Dimensions (mm)					
	R	L	H	B	LF	WF2	HF	LH
HFT DDXN R/L 2525M 1504	●	●	25	25	150	26,6	30	50

### ■ Spare Parts for Clamping System

Clamp	Spring	Clamp Bolt	Clamp Wrench			
SCP2 (Set)		5	LH040			

### ■ CBN-Inserts

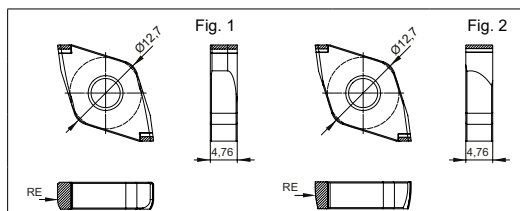

S01215: Chamfer 0,10-0,15x15° + Cutting edge rounded 10–20 µm  
E00200: Cutting edge rounded 10–20 µm

Cat. No.	Grade		RE (mm)	Outer Diam. Turning	Facing	Boring possible	Applicable Holder	Fig.
	BNC30G	BNC200						
DNXA 1504 R3 R S01215*	●	●	3	⊙	○	—	HFT DDXN R 2525M 1504	1
DNXA 1504 R3 L S01215**	●	●	3	⊙	○	—	HFT DDXN L 2525M 1504	1
DNXA 1504 R16 R S01215*	●	●	16	○	○	—	HFT DDXN R 2525M 1504	2
DNXA 1504 R16 L S01215**	●	●	16	○	○	—	HFT DDXN L 2525M 1504	2
DNXA 1504 R16 R E00200*		●	16	○	○	—	HFT DDXN R 2525M 1504	2
DNXA 1504 R16 L E00200**		●	16	○	○	—	HFT DDXN L 2525M 1504	2

\* Right handed (R) inserts can only be used in right handed (R) tools.

\*\* Left handed (L) inserts can only be used in left handed (L) tools.

⊙ Preferred choice  
○ Suitable  
— Not possible

### ■ Identification Details - Holder

HFT	DDXN	R/L	25	25	M	1504
Holder Description „High Feed Turning“	Clamping System D: Double Clamp D: Insert Shape X: Holder Style N: Relief Angle=0°	Feed Direction R: Right Hand L: Left Hand	Shank Height (H)	Shank Width (B)	Holder Length	Insert Size

● = Euro stock

# For Hardened Steel High Feed Turning (HFT-O)

## PSC50 HFT ID 25105 DOXN R/L 1204

Boring, Outer Diameter Turning possible

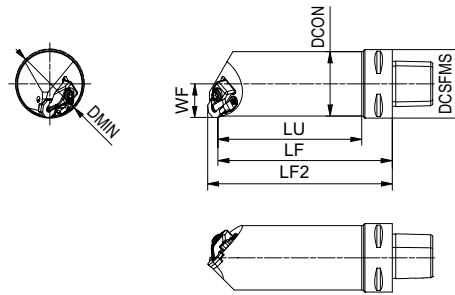
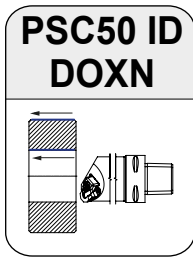

Above figures show right hand tools.

Attention: You need approximately 8 mm overhang on the shoulder (see page 2)

### ■ Holders

Cat. No.	Stock		Dimensions (mm)						
	R	L	DMIN	DCON	WF	LU	LF	LF2	DCSFMS
PSC50 HFT ID 25105 DOXN R/L 1204	●	●	50	47	24,5	105	127,3	134,8	50

### ■ Spare Parts for Clamping System

Clamp	Spring	Clamp Bolt	Clamp Wrench	Shim	Screw	Screw Wrench
SCP2 (Set)	5	LH040	CSCFHFT	MIB1.6-3	SDBSM	

### ■ Spare Parts for Coolant Supply

For Holder Left:	PSC50 HFT ID 25105 DOXN L 1204		For Holder Right:	PSC50 HFT ID 25105 DOXN R 1204	
Cooling Block Left	Screw	Seal	Cooling Block Right	Screw	Seal
CBLHFTSP (Set)			CBRHFTSP (Set)		

### ■ CBN-Inserts

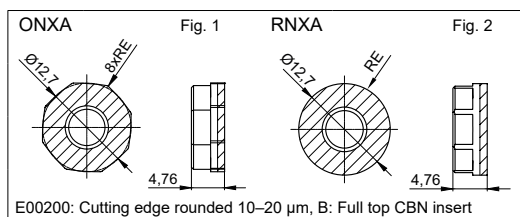

Cat. No.	Grade		RE (mm)	Boring	Outer Diam. Turning	Applicable Holder	Fig.
	BNC30G	BNC200					
ONXA 1204 R28 R E00200 B*	●	●	28	⊙	○	PSC50 HFT ID 25105 DOXN L 1204	1
ONXA 1204 R28 L E00200 B**	●	●	28	⊙	○	PSC50 HFT ID 25105 DOXN R 1204	1
ONXA 1204 R150 R E00200 B*	●	●	150	–	⊙	PSC50 HFT ID 25105 DOXN L 1204	1
ONXA 1204 R150 L E00200 B**	●	●	150	–	⊙	PSC50 HFT ID 25105 DOXN R 1204	1
RNXA 1204 N E00200 B***	●	●	6,35	○	○	PSC50 HFT ID 25105 DOXN R/L 1204	2

\* Right handed (R) inserts can only be used in left handed (L) tools.

\*\* Left handed (L) inserts can only be used in right (R) handed tools.

\*\*\* Can be used in right (R) or left handed (L) tool holders. Round inserts produce less cutting pressure when turning compared to octagonal inserts, but the quality of surface finish is also reduced.

⊙ Preferred choice

○ Suitable

– Not possible

### ■ Identification Details - Holder

PSC	50	HFT	ID	25	105	DOXN	R/L	1204
Polygon Shank	Shank Diameter	Holder Description „High Feed Turning“	Inner Diameter Turning	Cutting Edge Distance	Length of Use	Clamping System D: Double Clamp O: Insert Shape X: Holder Style N: Relief Angle=0°	Feed Direction R: Right Hand L: Left Hand	Insert Size

● = Euro stock

# For Hardened Steel High Feed Turning (HFT-O)

## PSC50 HFT OD 26065 DOXN R/L 1204

Outer Diameter Turning and Facing

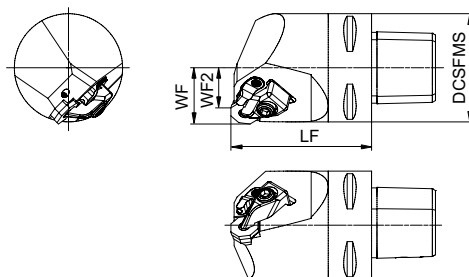
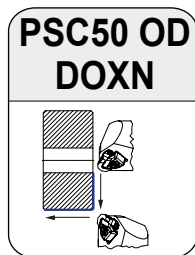

Above figures show right hand tools.

Attention: You need approximately 8 mm overhang on the shoulder (see page 2)

### ■ Holders

Cat. No.	Stock		Dimensions (mm)					
	R	L	WF	WF2	LF	DCSFMS		
PSC50 HFT OD 26065 DOXN R/L 1204	●	●	26	18,5	65	50		

### ■ Spare Parts for Clamping System

Clamp	Spring	Clamp Bolt	Clamp Wrench	Shim	Screw	Screw Wrench
SCP2 (Set)	5	5 (Nm)	LH040	CSCFHFT	MIB1.6-3	SDBSM

### ■ Spare Parts for Coolant Supply

For Holder Right:	PSC50 HFT OD 26065 DOXN R 1204		For Holder Left:	PSC50 HFT OD 26065 DOXN L 1204	
Cooling Block Left	Screw	Seal	Cooling Block Right	Screw	Seal
CBLHFTSP (Set)			CBRHFTSP (Set)		

### ■ CBN-Inserts

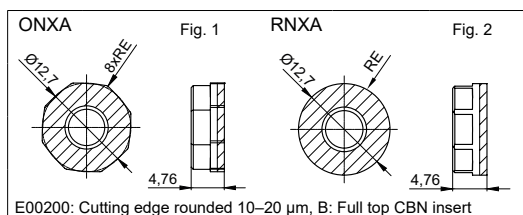

E00200: Cutting edge rounded 10–20 µm, B: Full top CBN insert

Cat. No.	Grade		RE (mm)	Outer Diam. Turning	Facing	Applicable Holder	Fig.
	BNC30G	BNC200					
ONXA 1204 R150 R E00200 B*	●	●	150	⊙	—	PSC50 HFT OD 26065 DOXN R 1204	1
ONXA 1204 R150 L E00200 B**	●	●	150	⊙	—	PSC50 HFT OD 26065 DOXN L 1204	1
ONXA 1204 R28 R E00200 B*	●	●	28	○	⊙	PSC50 HFT OD 26065 DOXN R 1204	1
ONXA 1204 R28 L E00200 B**	●	●	28	○	⊙	PSC50 HFT OD 26065 DOXN L 1204	1
RNXA 1204 N E00200 B***	●	●	6,35	○	○	PSC50 HFT OD 26065 DOXN R/L 1204	2

\* Right handed (R) inserts can only be used in right handed (R) tools.

\*\* Left handed (L) inserts can only be used in left handed (L) tools.

\*\*\* Can be used in right (R) or left handed (L) tool holders. Round inserts produce less cutting pressure when turning compared to octagonal inserts, but the quality of surface finish is also reduced.

⊙ Preferred choice

○ Suitable

— Not possible

### ■ Identification Details - Holder

PSC	50	HFT	OD	26	065	DOXN	R/L	1204
Polygon Shank	Shank Diameter	Holder Description „High Feed Turning“	Outer Diameter Turning	Cutting Edge Distance	Functional Length	Clamping System D: Double Clamp O: Insert Shape X: Holder Style N: Relief Angle=0°	Feed Direction R: Right Hand L: Left Hand	Insert Size

● = Euro stock



# For Hardened Steel High Feed Turning (HFT-D)

## PSC50 HFT OD 30065 DDXN R/L 1504

Outer Diameter Turning and Facing

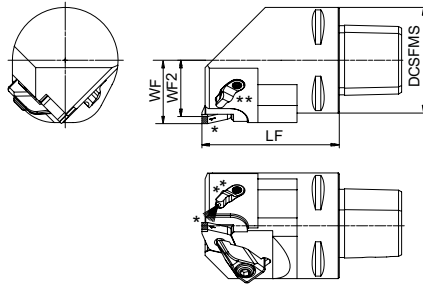
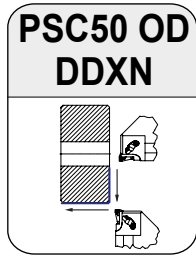

\* Note mounting position: Cutting edge number must be visible as shown.

\*\* Air / coolant outlet

Above figures show right hand tools.

Attention: You need approximately 3 mm overhang on the shoulder (see page 3)

### ■ Holders

Cat. No.	Stock		Dimensions (mm)					
	R	L	WF	WF2	LF	DCSFMS		
PSC50 HFT OD 30065 DDXN R/L 1504	●	●	30	26,6	65	50		

### ■ Spare Parts for Clamping System

Clamp	Spring	Clamp Bolt	Clamp Wrench			
SCP2 (Set)		5  (N·m)	LH040			

### ■ Spare Parts for Coolant Supply

For Holder Right:	PSC50 HFT OD 30065 DDXN <b>R</b> 1504		For Holder Left:	PSC50 HFT OD 30065 DDXN <b>L</b> 1504	
Cooling Block Left	Screw	Seal	Cooling Block Right	Screw	Seal
CBLHFTSP (Set)			CBRHFTSP (Set)		

### ■ CBN-Inserts

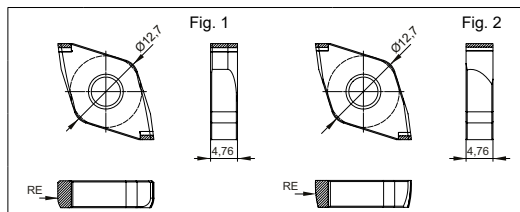

S01215: Chamfer 0,10-0,15x15° + Cutting edge rounded 10–20 µm  
E00200: Cutting edge rounded 10–20 µm

Cat. No.	Grade		RE (mm)	Outer Diam. Turning	Facing	Applicable Holder	Fig.
	BNC30G	BNC200					
DNXA 1504 R3 <b>R</b> S01215*	●	●	3	⊙	○	PSC50 HFT OD 30065 DDXN <b>R</b> 1504	1
DNXA 1504 R3 <b>L</b> S01215**	●	●	3	⊙	○	PSC50 HFT OD 30065 DDXN <b>L</b> 1504	1
DNXA 1504 R16 <b>R</b> S01215*	●	●	16	○	○	PSC50 HFT OD 30065 DDXN <b>R</b> 1504	2
DNXA 1504 R16 <b>L</b> S01215**	●	●	16	○	○	PSC50 HFT OD 30065 DDXN <b>L</b> 1504	2
DNXA 1504 R16 <b>R</b> E00200*		●	16	○	○	PSC50 HFT OD 30065 DDXN <b>R</b> 1504	2
DNXA 1504 R16 <b>L</b> E00200**		●	16	○	○	PSC50 HFT OD 30065 DDXN <b>L</b> 1504	2

\* Right handed (R) inserts can only be used in right handed (R) holders.

\*\* Left handed (L) inserts can only be used in left handed (L) holders.

⊙ Preferred choice  
○ Suitable

### ■ Identification Details - Holder

PSC	50	HFT	OD	30	065	DDXN	R/L	1504
Polygon Shank	Shank Diameter	Holder Description „High Feed Turning“	Outer Diameter Turning	Cutting Edge Distance	Functional Length	Clamping System D: Double Clamp D: Insert Shape X: Holder Style N: Relief Angle=0°	Feed Direction R: Right Hand L: Left Hand	Insert Size

# For Hardened Steel High Feed Turning (HFT-D)

## PSC50 HFT ID 25055 DDXN R/L 1504

Boring, Outer Diameter Turning possible

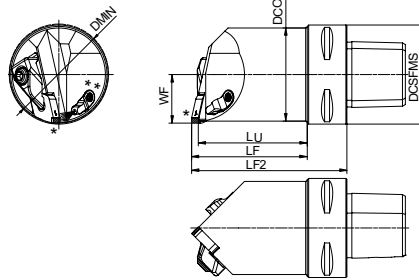
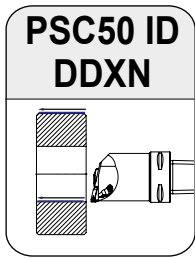

\* Note mounting position: Cutting edge number must be visible as shown.

\*\* Air / coolant outlet

Above figures show right hand tools.

Attention: You need approximately 3 mm overhang on the shoulder (see page 3)

### ■ Holders

Cat. No.	Stock		Dimensions (mm)						
	R	L	DMIN	DCON	WF	LU	LF	LF2	DCSFMS
PSC50 HFT ID 25055 DDXN R/L 1504	●	●	50	47	24,5	55	58,4	78,4	50

### ■ Spare Parts for Clamping System

Clamp	Spring	Clamp Bolt	Clamp Wrench			
SCP2 (Set)		5	LH040			

### ■ Spare Parts for Coolant Supply

For Holder Left:	PSC50 HFT ID 25055 DDXN <b>L</b> 1504		For Holder Right:	PSC50 HFT ID 25055 DDXN <b>R</b> 1504	
Cooling Block Left	Screw	Seal	Cooling Block Right	Screw	Seal
CBLHFTSP (Set)			CBRHFTSP (Set)		

### ■ CBN-Inserts

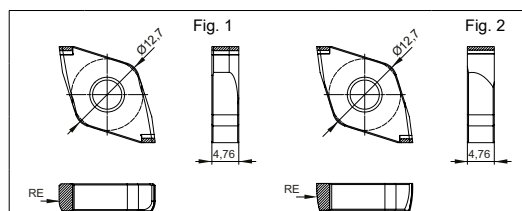

S01215: Chamfer 0,10-0,15x15° + Cutting edge rounded 10–20 µm  
E00200: Cutting edge rounded 10–20 µm

Cat. No.	Grade		RE (mm)	Boring	Outer Diam. Turning	Applicable Holder	Fig.
	BNC30G	BNC200					
DNXA 1504 R16 R S01215*	●	●	16	⊙	○	PSC50 HFT ID 25055 DDXN L 1504	2
DNXA 1504 R16 L S01215**	●	●	16	⊙	○	PSC50 HFT ID 25055 DDXN R 1504	2
DNXA 1504 R16 R E00200*		●	16	○	○	PSC50 HFT ID 25055 DDXN L 1504	2
DNXA 1504 R16 L E00200**		●	16	○	○	PSC50 HFT ID 25055 DDXN R 1504	2
DNXA 1504 R3 R E00200*	●	●	3	—	⊙	PSC50 HFT ID 25055 DDXN L 1504	1
DNXA 1504 R3 L E00200**	●	●	3	—	⊙	PSC50 HFT ID 25055 DDXN R 1504	1

\* Right handed (R) inserts can only be used in left handed (L) tools.

\*\* Left handed (L) inserts can only be used in right handed (R) tools.

⊙ Preferred choice  
○ Suitable  
— Not possible

### ■ Identification Details - Holder

PSC	50	HFT	ID	25	055	DDXN	R/L	1504
Polygon Shank	Shank Diameter	Holder Description „High Feed Turning“	Inner Diameter Turning	Cutting Edge Distance	Length of Use	Clamping System D: Double Clamp D: Insert Shape X: Holder Style N: Relief Angle=0°	Feed Direction R: Right Hand L: Left Hand	Insert Size

● = Euro stock

# For Hardened Steel High Feed Turning (HFT-D)

## PSC50 HFT ID 35055 DDXN R/L 1504

Boring, Outer Diameter Turning possible

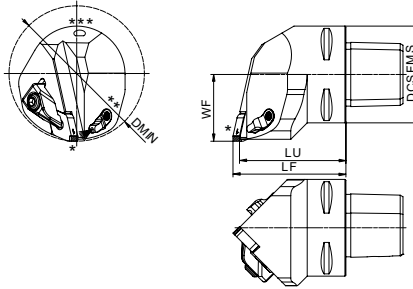
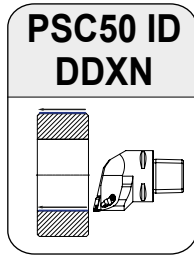

\* Note mounting position: Cutting edge number must be visible as shown.

\*\* Air / coolant outlet

\*\*\* Screw plugs for air / coolant transfer shall not be removed.

Above figures show right hand tools.

Attention: You need approximately 3 mm overhang on the shoulder (see page 3)

### ■ Holders

Cat. No.	Stock		Dimensions (mm)					DCSFMS
	R	L	DMIN	WF	LU	LF		
PSC50 HFT ID 35055 DDXN R/L 1504	●	●	70	34,5	55	58,4	50	

### ■ Spare Parts for Clamping System

Clamp	Spring	Clamp Bolt	Clamp Wrench			
SCP2 (Set)		5	LH040			

### ■ Spare Parts for Coolant Supply

For Holder Left:	PSC50 HFT ID 35055 DDXN L 1504		For Holder Right:	PSC50 HFT ID 35055 DDXN R 1504	
Cooling Block Left	Screw	Seal	Cooling Block Right	Screw	Seal
CBLHFTSP (Set)			CBRHFTSP (Set)		

### ■ CBN-Inserts

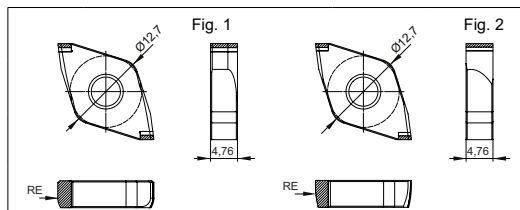

S01215: Chamfer 0,10-0,15x15° + Cutting edge rounded 10–20 µm  
E00200: Cutting edge rounded 10–20 µm

Cat. No.	Grade		RE (mm)	Boring	Outer Diam. Turning	Applicable Holder	Fig.
	BNC30G	BNC200					
DNXA 1504 R16 R S01215*	●	●	16	⊙	○	PSC50 HFT ID 25055 DDXN L 1504	2
DNXA 1504 R16 L S01215**	●	●	16	⊙	○	PSC50 HFT ID 25055 DDXN R 1504	2
DNXA 1504 R16 R E00200*		●	16	○	○	PSC50 HFT ID 25055 DDXN L 1504	2
DNXA 1504 R16 L E00200**		●	16	○	○	PSC50 HFT ID 25055 DDXN R 1504	2
DNXA 1504 R3 R E00200*	●	●	3	—	⊙	PSC50 HFT ID 25055 DDXN L 1504	1
DNXA 1504 R3 L E00200**	●	●	3	—	⊙	PSC50 HFT ID 25055 DDXN R 1504	1

\* Right handed (R) inserts can only be used in left handed (L) tools.

\*\* Left handed (L) inserts can only be used in right handed (R) tools.

⊙ Preferred choice

○ Suitable

— Not possible

### ■ Identification Details - Holder

PSC	50	HFT	ID	35	055	DDXN	R/L	1504
Polygon Shank	Shank Diameter	Holder Description „High Feed Turning“	Inner Diameter Turning	Cutting Edge Distance	Length of Use	Clamping System D: Double Clamp D: Insert Shape X: Holder Style N: Relief Angle=0°	Feed Direction R: Right Hand L: Left Hand	Insert Size

# For Hardened Steel High Feed Turning (HFT-O)

## VDI40 HFT OD 43065 DOXN R/L 1204

Outer Diameter Turning and Facing

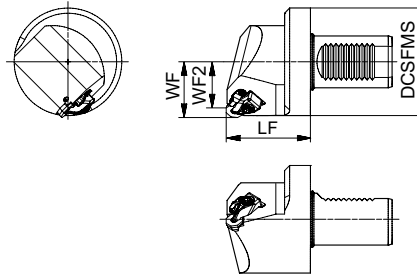
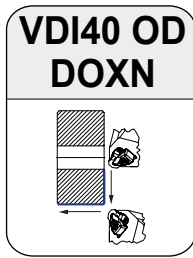

Above figures show right hand tools.

Attention: You need approximately 8 mm overhang on the shoulder (see page 2)

### ■ Holders

Cat. No.	Stock		Dimensions (mm)				
	R	L	WF	WF2	LF	DCSFMS	
VDI40 HFT OD 43065 DOXN R/L 1204	●	●	43	35,5	65	83	

### ■ Spare Parts for Clamping System

Clamp	Spring	Clamp Bolt	Clamp Wrench	Shim	Screw	Screw Wrench
SCP2 (Set)	5	5	LH040	CSCFHFT	MIB1.6-3	SDBSM

### ■ Spare Parts for Coolant Supply

For Holder Right:	VDI40 HFT OD 43065 DOXN R 1204		For Holder Left:	VDI40 HFT OD 43065 DOXN L 1204	
Cooling Block Left	Screw	Seal	Cooling Block Right	Screw	Seal
CBLHFTSP (Set)			CBRHFTSP (Set)		

### ■ CBN-Inserts

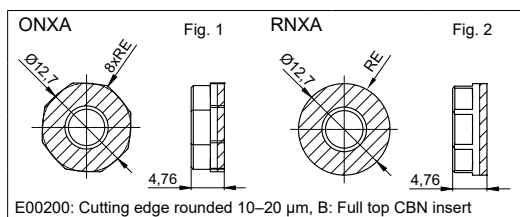

Cat. No.	Grade		RE (mm)	Outer Diam. Turning	Facing	Applicable Holder	Fig.
	BNC30G	BNC200					
ONXA 1204 R150 R E00200 B*	●	●	150	○	—	VDI40 HFT OD 43065 DOXN R 1204	1
ONXA 1204 R150 L E00200 B**	●	●	150	○	—	VDI40 HFT OD 43065 DOXN L 1204	1
ONXA 1204 R28 R E00200 B*	●	●	28	○	○	VDI40 HFT OD 43065 DOXN R 1204	1
ONXA 1204 R28 L E00200 B**	●	●	28	○	○	VDI40 HFT OD 43065 DOXN L 1204	1
RNXA 1204 N E00200 B***	●	●	6,35	○	○	VDI40 HFT OD 43065 DOXN R/L 1204	2

\* Right handed (R) inserts can only be used in right handed (R) tools.

\*\* Left handed (L) inserts can only be used in left handed (L) tools.

\*\*\* Can be used in right (R) or left (L) handed tool holders. Round inserts produce less cutting pressure when turning compared to octagonal inserts, but the quality of surface finish is also reduced.

○ Preferred choice

○ Suitable

— Not possible

### ■ Identification Details - Holder

VDI	40	HFT	OD	43	065	DOXN	R/L	1204
Cylindrical Shank	Shank Diameter	Holder Description „High Feed Turning“	Outer Diameter Turning	Cutting Edge Distance	Functional Length	Clamping System D: Double Clamp O: Insert Shape X: Holder Style N: Relief Angle=0°	Feed Direction R: Right Hand L: Left Hand	Insert Size

● = Euro stock

# For Hardened Steel High Feed Turning (HFT-O)

## VDI40 HFT ID 25105 DOXN R/L 1204

Boring, Outer Diameter Turning possible

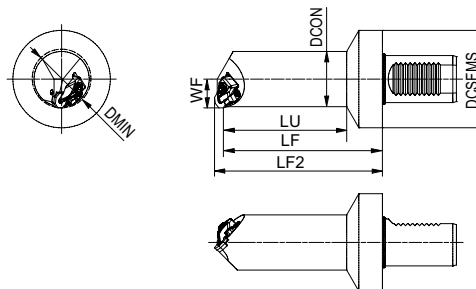
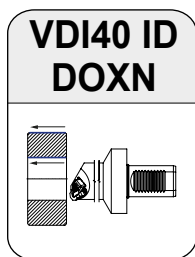

Above figures show right hand tools.

Attention: You need approximately 8 mm overhang on the shoulder (see page 2)

### ■ Holders

Cat. No.	Stock		Dimensions (mm)						
	R	L	DMIN	DCON	WF	LU	LF	LF2	DCSFMS
VDI40 HFT ID 25105 DOXN R/L 1204	●	●	50	47	24,5	105	135,4	142,8	83

### ■ Spare Parts for Clamping System

Clamp	Spring	Clamp Bolt	Clamp Wrench	Shim	Screw	Screw Wrench
SCP2 (Set)	5	5	LH040	CSCFHFT	MIB1.6-3	SDBSM

### ■ Spare Parts for Coolant Supply

For Holder Left:	VDI40 HFT ID 25105 DOXN L 1204		For Holder Right:	VDI40 HFT ID 25105 DOXN R 1204	
Cooling Block Left	Screw	Seal	Cooling Block Right	Screw	Seal
CBLHFTSP (Set)			CBRHFTSP (Set)		

### ■ CBN-Inserts

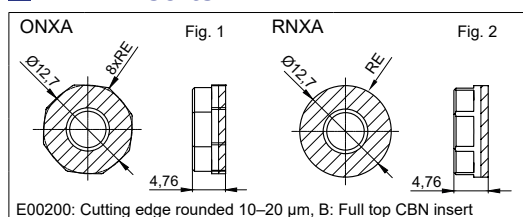

Cat. No.	Grade		RE (mm)	Boring	Outer Diam. Turning	Applicable Holder	Fig.
	BNC30G	BNC200					
ONXA 1204 R28 R E00200 B*	●	●	28	⊙	○	VDI40 HFT ID 25105 DOXN L 1204	1
ONXA 1204 R28 L E00200 B**	●	●	28	⊙	○	VDI40 HFT ID 25105 DOXN R 1204	1
ONXA 1204 R150 R E00200 B*	●	●	150	—	⊙	VDI40 HFT ID 25105 DOXN L 1204	1
ONXA 1204 R150 L E00200 B**	●	●	150	—	⊙	VDI40 HFT ID 25105 DOXN R 1204	1
RNXA 1204 N E00200 B***	●	●	6,35	○	○	VDI40 HFT ID 25105 DOXN R/L 1204	2

\* Right handed (R) inserts can only be used in left handed (L) tools.

\*\* Left handed (L) inserts can only be used in right handed (R) tools.

\*\*\* Can be used in right (R) or left (L) handed tool holders. Round inserts produce less cutting pressure when turning compared to octagonal inserts, but the quality of surface finish is also reduced.

⊙ Preferred choice

○ Suitable

— Not possible

### ■ Identification Details - Holder

VDI	40	HFT	ID	25	105	DOXN	R/L	1204
Cylindrical Shank	Shank Diameter	Holder Description „High Feed Turning“	Inner Diameter Turning	Cutting Edge Distance	Length of Use	Clamping System D: Double Clamp O: Insert Shape X: Holder Style N: Relief Angle=0°	Feed Direction R: Right Hand L: Left Hand	Insert Size

● = Euro stock

# For Hardened Steel High Feed Turning (HFT-O)

## ■ Technical Details

### Spare Parts for HFT-O Square shank holder



### Spare Parts for Clamping System:

- ① SCP2 → Clampset
- ② LH040 → Clamp Wrench
- ③ CSCFHFT → Shim
- ④ MIB1.6-3 → Screw
- ⑤ SDBSM → Screw Wrench

### Spare Parts for VDI40-, PSC50 HFT-O Toolholders

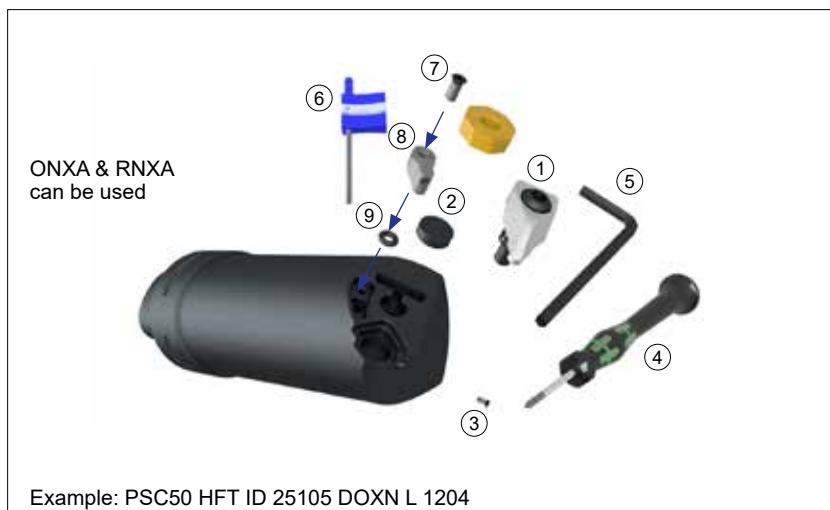

### Spare Parts for Clamping System:

- ① SCP2 → Clampset
- ② CSCFHFT → Shim
- ③ MIB1.6-3 → Screw
- ④ SDBSM → Screw Wrench
- ⑤ LH040 → Clamp Wrench
- ⑥ TRX10 → Torx Wrench

### Spare Part Set for Coolant Supply:

- CBLHFTSP/
  - CBRHFTSP
- ⑦ Screw
  - ⑧ Coolant Block
  - ⑨ Seal

# For Hardened Steel High Feed Turning (HFT-D)

## ■ Technical Details

### Spare Parts for HFT-D Shank

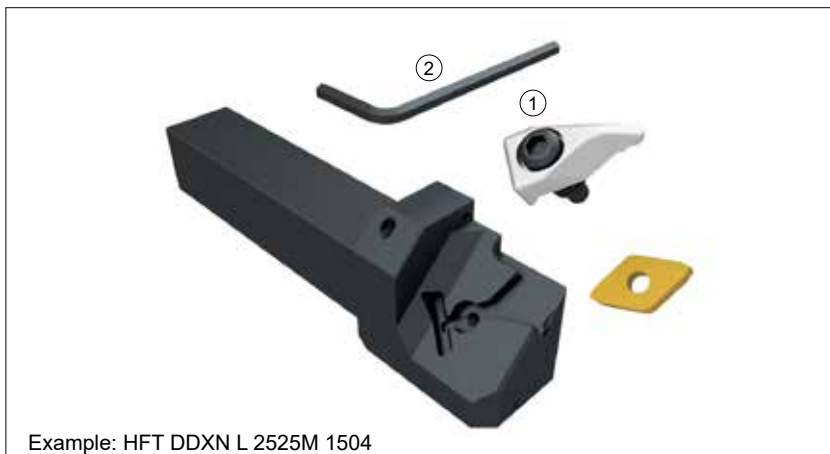

### Spare Parts for Clamping System:

- ① SCP2 → Clampset
- ② LH040 → Clamp Wrench

### Spare Parts for PSC50 HFT-D Toolholders



### Spare Parts for Clamping System:

- ① SCP2 → Clampset
- ② LH040 → Clamp Wrench
- ③ TRX10 → Torx Wrench

### Spare Part Set for Coolant Supply:

- ④ Screw
- ⑤ Coolant Block
- ⑥ Seal

# For Hardened Steel High Feed Turning



**CARBIDE - CBN - DIAMOND**

(Germany)  
SUMITOMO ELECTRIC Hartmetall GmbH  
Konrad-Zuse-Straße 9, 47877 Willich

Tel. +49 2154 4992-0, Fax +49 2154 4992-161  
Info@SumitomoTool.com  
www.SumitomoTool.com



(UK and Ireland)  
SUMITOMO ELECTRIC Hardmetal Ltd.  
3 Paper Mill Drive  
Redditch, B98 8QJ, UK

Tel. +44 1844 342081, Fax: +44 1844 342415  
InfoUK@SumitomoTool.com  
www.SumitomoTool.com



Distributed by: